

Stacking Sequence and Preload Valve, size 5 with integral Bypass Check Valve, Seated Pilot Stage, Spool-type Main Stage, Series SDVB-3 ...



- 350 bar, 140 l/min
- With two-stage 10 mm pressure relief cartridge DVPA-3-10...
- 350 bar, 140 l/min on all ports
- Cartridge spring chamber is drained to port T
- Optionally available with hand knob, or lockable hand knob, adjuster
- Also available with solenoid controlled two-pressure cartridge WUVPB-3...-10
- ISO 4401 / CETOP R35H size 5, NFPA D05, DIN 24 340 A10 interface

1. Description

Series SDVB-3...-10 stack valves are used for sequence- and preload functions. They are equipped with the two-stage pressure relief cartridge type DVPA-3-10... . When closed, the valves shut off the relief path with spool-type leakage (see performance graphs). The cartridge spring chamber is drained to port T - the pressure setting is unaffected by fluctuations of the secondary pressure. The bypass

check valve in models SDVB-3-...AR-10... and SDVB-3-...BR-10... allows reverse flow from A1 to A, or B1 to B.

NOTE: after the connection P → P1 (or A → A1, B → B1) has opened, pilot oil drain flow to T will increase with rising system pressure (see performance graphs).

Turning model SDVB-3-AAZR-10 upside down about its short axis pro-

duces the SDVB-3-BBAR-10 function and vice versa. Ditto SDVB-3-AAAR-10 and ...-BBZR... The side-mounted nameplate indicates the correct orientation for the required function. The screw-in design of the cartridge valve provides for straight-forward, trouble-free maintenance. Interface sealing is by means of a seal plate and 5 O-rings.

2. Symbols

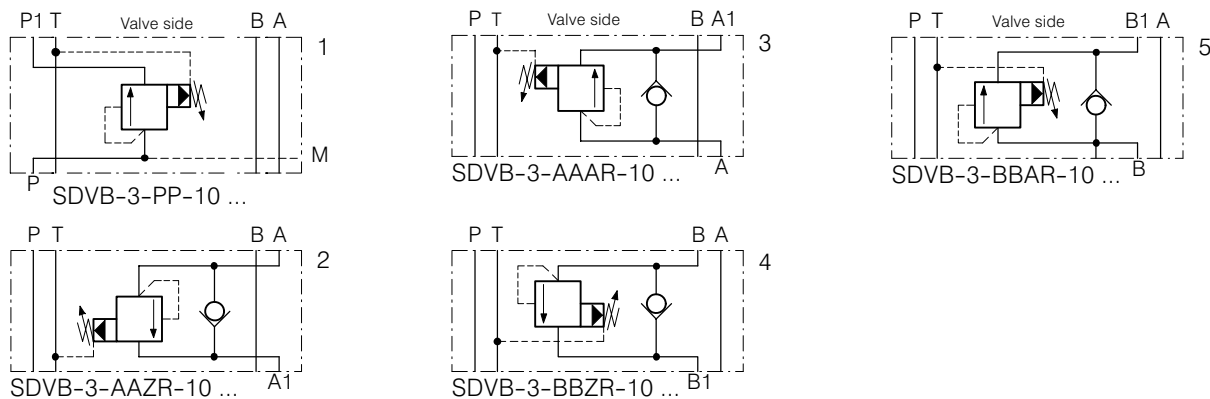

3. Main characteristics

Designation		Stacking pressure sequence valve
Design		two-stage, seated pilot, sliding spool
Mounting method		stack mounting
Size		ISO 4401 size 5 interface
Weight	kg	SDVB-3-PP-10 ... = 2,9, SDVB-3-...AR / ZR-10 ... = 2,8

Mounting attitude		unrestricted
Flow direction		see symbols
Operating pressure range	bar	... 350 in P, A, B and T
Adjustment ranges	bar	pressure range N = 010 ... 350 pressure range M = 010 ... 210 pressure range L = 010 ... 065
Flow rate, Q _{max}	l/min	1 ... 140, see performance limits
Fluids		HL and HLP hydraulic oils to DIN 51 524; for other fluids, please consult BUCHER
Fluid temperature range	°C	-25 ... +85
Ambient temperature	°C	-25 ... +85
Viscosity range	mm ² /s (cSt)	10 ... 650, recommended 15 ... 250
Minimum fluid cleanliness level		18/14 to ISO 4406 / CETOP RP70H; 8 ... 9 to NAS 1638

4. Performance graphs

Measured with oil viscosity 33 mm²/s (cSt)

SDVB-3-PP-10-..N
p-Q characteristics
with p in T = 0 (bar)

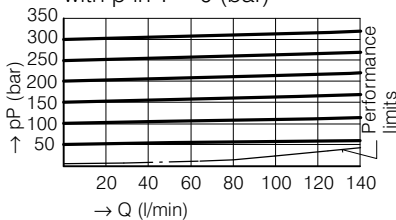

SDVB-3-PP-10-..M
p-Q characteristics
with p in T = 0 (bar)

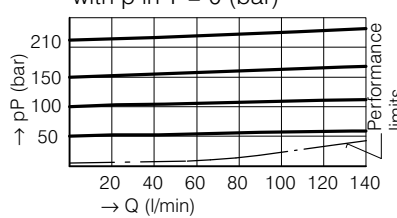

SDVB-3-PP-10-..L
p-Q characteristics
with p in T = 0 (bar)

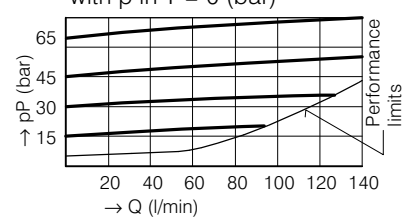

SDVB-3-..AR / ZR-10-..N
p-Q characteristics
with p in T = 0 (bar)

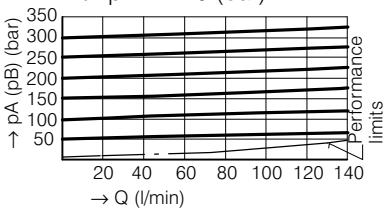

SDVB-3-..AR / ZR-10-..M
p-Q characteristics
with p in T = 0 (bar)

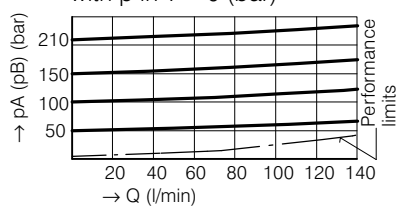

SDVB-3-..AR / ZR-10-..L
p-Q characteristics
with p in T = 0 (bar)

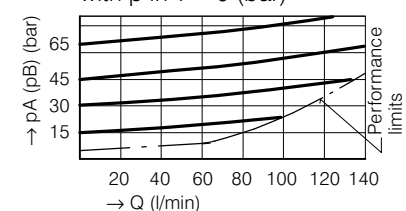

Leakage P→P1

A→A1, B→B1

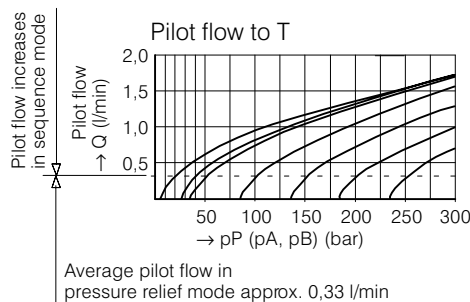
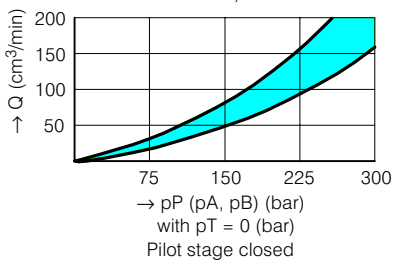

Δp-Q char. A1→A bzw. B1→B
through bypass check valve

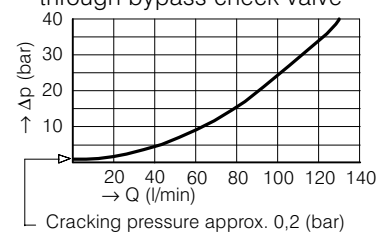

Rate of pressure change
when turning the adjusting screw:

SDVB-3-..-10-..N1 turn	≅ app. 60 (bar)
SDVB-3-..-10-..Mt turn	≅ app. 38 (bar)
SDVB-3-..-10-..L1 turn	≅ app. 13 (bar)

5. Dimensions

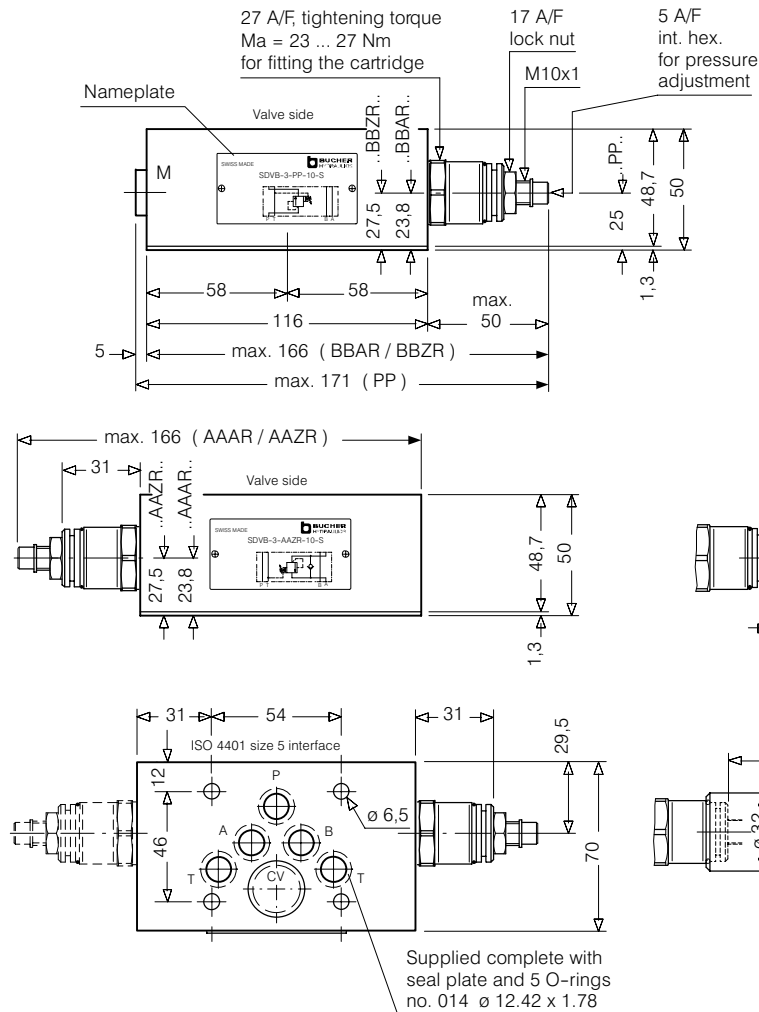

OPTIONS

Adjuster style H
Hand knob (can be
fitted later by user)

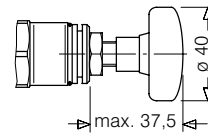

Adjuster style Z4
Lockable hand knob
type 2H complies with
Volkswagen Factory
Specification BV 1.09
(factory option only)

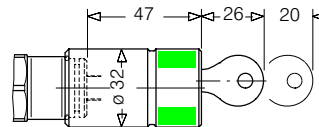

6. Schematic section

showing the relevant ports
Ex. SDVB-3-BBZR-10 ...

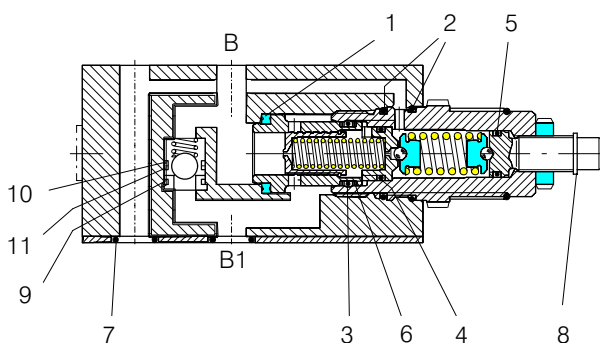

Seal kit no. DS-221, comprising *):

ltn.	Qty.	Qty.	Description	Size
1	1	1*)	Seal	Ø 22,1 x 16,5 x 2,5
2	2	2*)	O-ring no. 020	Ø 21,95 x 1,78 N90
3	1	1*)	O-ring	Ø 14 x 2
4	1	1*)	O-ring no. 013	Ø 10,82 x 1,78 N90
5	1	1*)	O-ring no. 012	Ø 9,25 x 1,78 N90
6	2	2*)	Backup ring	Ø 13,7/1,5x1,4 FI0751
7	5	5*)	O-ring no. 014	Ø 12,42 x 1,78 N90
8	1	1*)	Snap ring	Ø 9 type SS
9	-	1*)	O-ring no. 018	Ø 18,77 x 1,78 N90
10	-	1*)	O-ring no. 016	Ø 15,60 x 1,78 N90
11	-	1*)	Backup ring	Ø 15,3/1,5x1,4 FI0751

SDVB-3-AAAR/ZR / BBAR/ZR-10 ...
SDVB-3-PP-10 ...

7. Installation and servicing

All installation and servicing must be carried out with care, and by qualified personnel only. At installation, be sure to mount the valve with the correct

faces contacting the adjacent units and with all interface connections lining up properly. When changing seals, the new seals should be thoroughly oiled or

greased before fitting them to the valve. Use the correct tightening torques when fitting the cartridge.

8. Ordering code

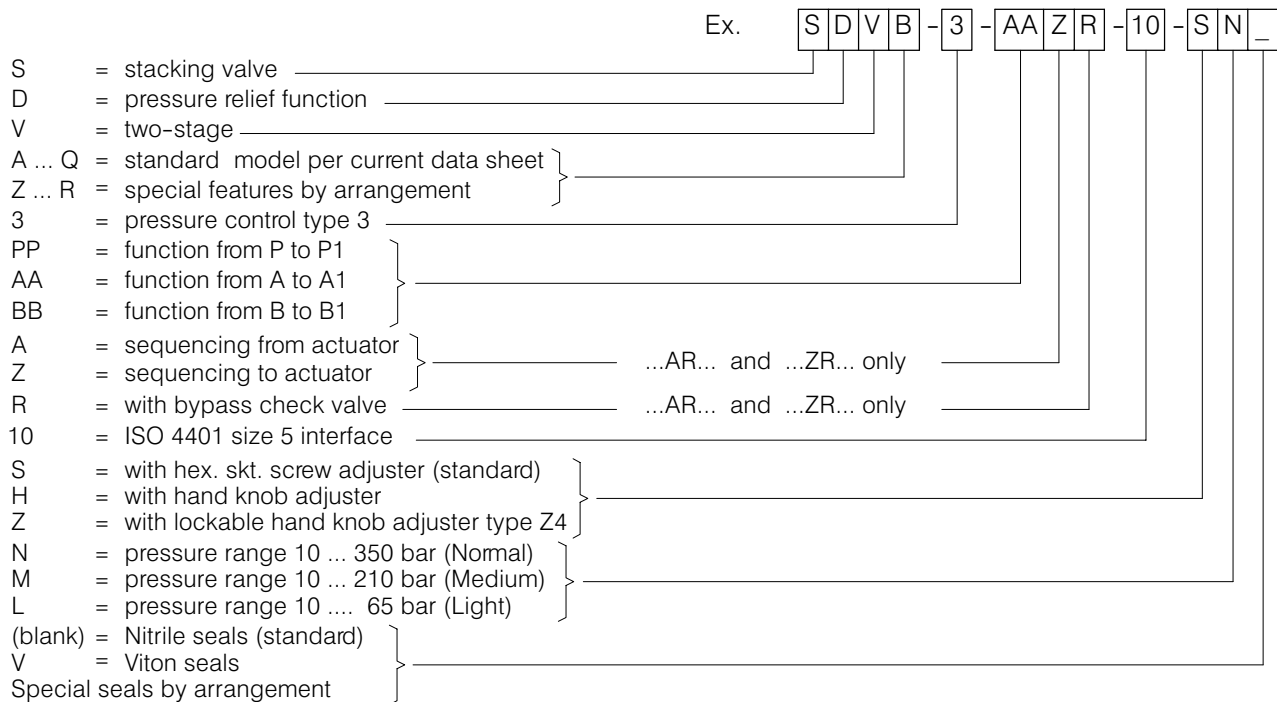

9. Related data sheets

Old no.	New no.	
i-00	400-P-010101-E	Table of interface equivalents
i-41	400-P-050101-E	DIN 24 340 size A10 interface
D-4.33	400-P-280121-E	Two-stage pressure relief cartridge, 10 mm, series DVPA-3-10 ...
G-45	400-P-810901-E	Seal plate type DB-10

BUCHER HYDRAULICS

Germany

Phone +49 7742 85 20
Fax +49 7742 71 16
info.de@bucherhydraulics.com

France

Phone +33 389 64 22 44
Fax +33 389 65 28 78
info.fr@bucherhydraulics.com

Netherlands

Phone +31 79 34 26 24 4
Fax +31 79 34 26 28 8
info.nl@bucherhydraulics.com

UK

Phone +44 24 76 35 35 61
Fax +44 24 76 35 35 72
info.uk@bucherhydraulics.com

USA

Phone +1 262 605 82 80
Fax +1 262 605 82 78
info.wi@bucherhydraulics.com

www.bucherhydraulics.com

Switzerland

Phone +41 33 67 26 11 1
Fax +41 33 67 26 10 3
info.ch@bucherhydraulics.com

Italy

Phone +39 0522 92 84 11
Fax +39 0522 51 32 11
info.it@bucherhydraulics.com

Austria

Phone +43 6216 44 97
Fax +43 6216 44 97 4

China

Phone +86 10 64 44 32 88
Fax +86 10 64 44 32 35
info.bj@bucherhydraulics.com

Product Center (Elevator)

Phone +41 41 757 03 33
Fax +41 41 757 16 49
info.nh@bucherhydraulics.com

We reserve the right of modification without notice.