

Electrically Operated Pressure-Reducing Cartridge, Size 16 Seated Pilot Stage, Spool-Type Main Stage Series WDRVPA-5 ...

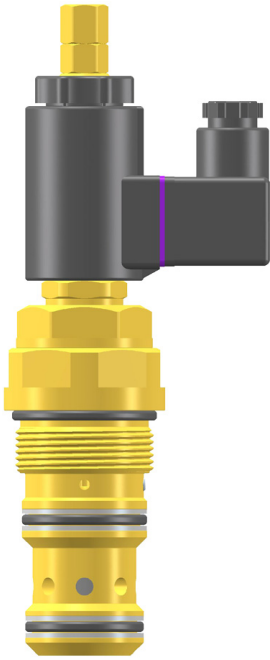

- 250 l/min, 350 bar
- Two-pressure valve, HI / LO
- External pilot drain to port 3
- Surface protection:
Cartridge is chromited, Cr VI-free
- Very stable operation
- Coil can be changed without opening the hydraulic envelope
- Coils with DIN, Deutsch, Kostal or Junior Timer plug connections can be supplied
- Can be fitted in a line-mounting body
- Can be fitted in stack-mounting-bodies

1. Description

Series WDRVPA-5... cartridges are electrically operated two-stage pressure-reducing valves with a seated pilot stage and a spool-type main stage. Using the external pressure adjustment, the higher reduced pressure p1 and the lower reduced pressure p2 can be varied smoothly and independently of one another without opening the hydraulic envelope, and either pressure can be selected. The WDRVPA-5... has an external pilot oil drain to 3. When the pilot stage is active, pilot oil is drained externally to port 3. For customers who manufacture their own manifold blocks, we offer form-tool sets for sale or hire. Use the GEBAA body with threaded ports (G1") for line-mounting applications.

2. Symbol

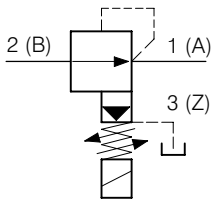

3. Main characteristics

| | | |
|-------------------------------------|-------|---|
| Designation | | pressure-reducing cartridge for 2 electrically selectable reduced pressures |
| Design | | seated pilot stage, spool-type main stage with external pilot oil drain to 3 |
| Mounting method | | screw-in cartridge (M42 x 2) |
| Size | | nominal size 16 mm, cavity type EB to ISO 7789-42-06-0-07 |
| Weight | kg | 1.25 |
| Mounting attitude | | unrestricted |
| Flow direction | | 2 → 1 (see symbol) |
| Operating pressure range in 1 and 2 | bar | ... 350 |
| Back pressure in 3 (Tank) | bar | max. 20 |
| Pressure-setting range p1 | bar | pressure range 35 = 15 ... 350 pressure range 25 = 15 ... 250 pressure range 16 = 15 ... 160 pressure range 10 = 15 ... 100 pressure range 04 = 10 ... 40 |
| Flow rate, Q _{max.} | l/min | 1 ... 250, see performance graphs |
| Hydraulic fluid | | HL and HLP hydraulic oils to DIN 51 524; for other fluids, please consult BUCHER |

| | | |
|---------------------------------|-----------------------------|--|
| Fluid temperature range | °C | -25 ... +80 |
| Ambient temperature | °C | -25 ... +50 |
| Viscosity range | mm ² /s (cSt) | 10 ... 500 recommended 15 ... 250 |
| Minimum fluid cleanliness level | | 20/18/15 to ISO 4406 : 1999 |
| Nominal voltages | VAC VDC | 115, 230, (50..60 Hz) 12, 24 |
| Nominal voltage tolerance | % | ± 10 |
| Nominal power consumption | W | VAC = 25, VDC = 27 |
| Relative duty cycle | % | 100 |
| Protection class | | IP 65 / IP 67, see "Ordering code" (when connector plugs are properly fitted) |
| Electrical connection | | 3-pin square plug to DIN EN 175301-803 (standard) for other connectors, see "Ordering code" |

4. Performance graphs

measured with oil viscosity 33 mm²/s (cSt) coil at steady-state temperature and 10 % undervoltage

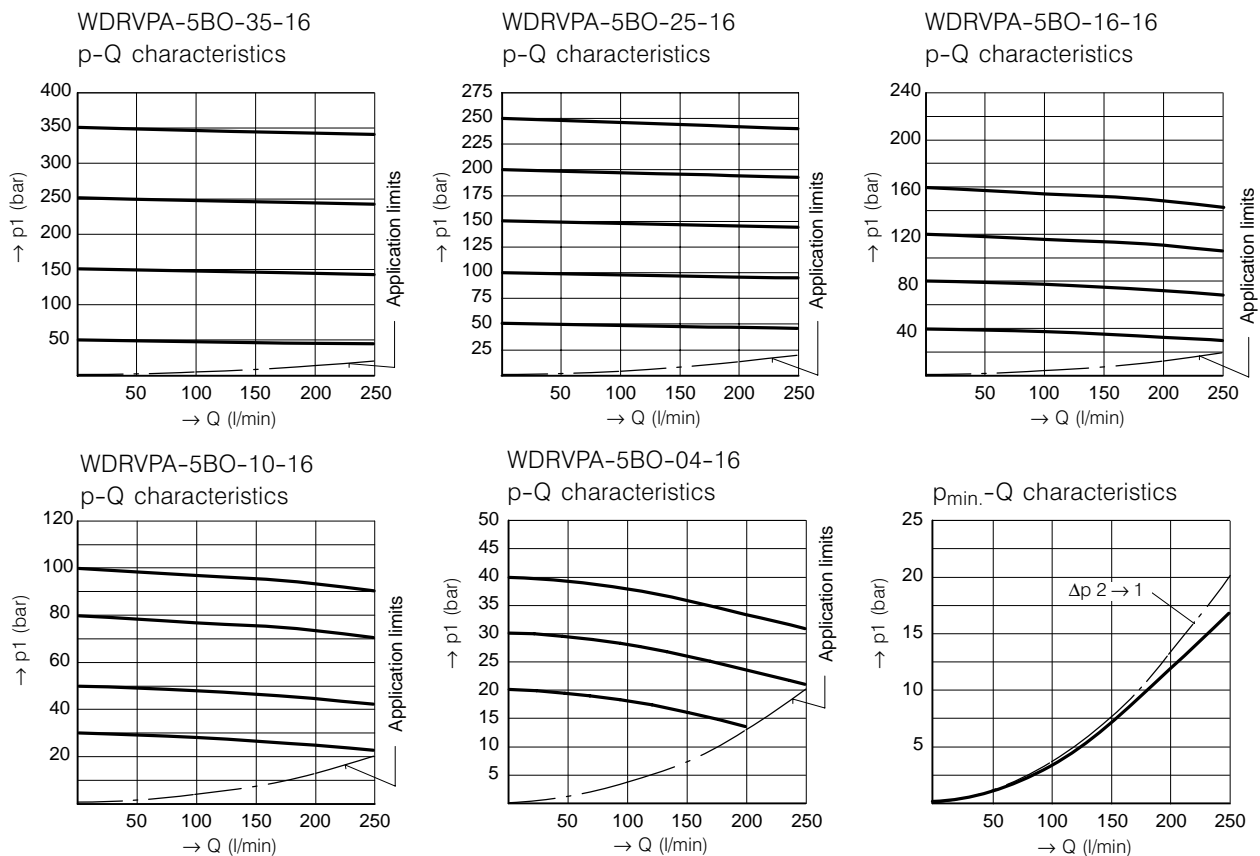

| Switching times | ON | OFF |
|-----------------|---------------|---------|
| WDRVPA-5...-16 | 50 ... 300 ms | ≤ 30 ms |

The switching times are influenced by flow rate, pressure, supply voltage, coil temperature, and oil viscosity.

Pilot oil consumption at port 3

| | |
|----------------|----------------------------------|
| WDRVPA-5...-16 | 300 ... 500 cm ³ /min |
| | |

5. Setting the pressures

(pressure p1 must be set first, followed by pressure p2)

Setting the higher pressure p1

with pump running and solenoid energised:

1. Slacken cap nut item 12 and remove it.
2. Slacken lock nut item 11 (13 A/F) approx. 1/2 turn.
3. With pump running and solenoid energised, use the two flats (7 A/F) to turn adjusting screw item 9 until the required reduced pressure is set in port 1.
4. Hold the adjusting screw item 9 using the 7 A/F flats while tightening the lock nut item 11 (13 A/F).
5. Refit cap nut item 12 and tighten it.

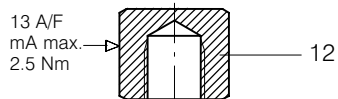

When setting pressure p1, do not over-tighten the adjusting screw item 9 as this can destroy the stop-ring that limits the maximum pressure setting. Stop turning as soon as a definite end-stop can be felt.

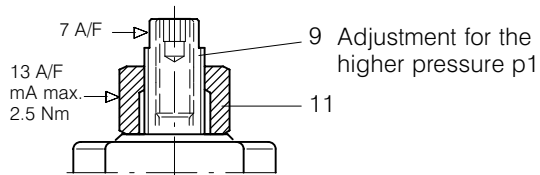

Setting the lower pressure p2

(second relief setting, or vented pressure) with pump running and solenoid de-energised:

1. Slacken cap nut item 12 and remove it.
2. With pump running and solenoid de-energised, use the adjusting screw item 10 (2.5 A/F hex. socket) to set the reduced pressure p2 in port 1. (p2 min.: 11 ... 35 bar, dependent on flow rate).
3. Refit cap nut item 12 and tighten it.

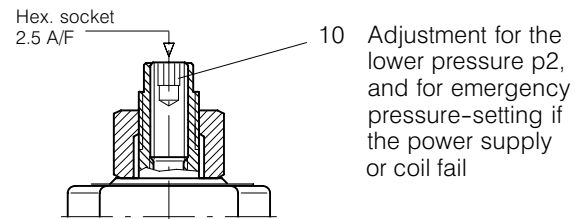
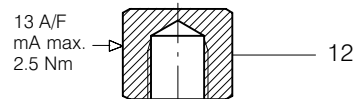

6. Dimensions / Schematic section

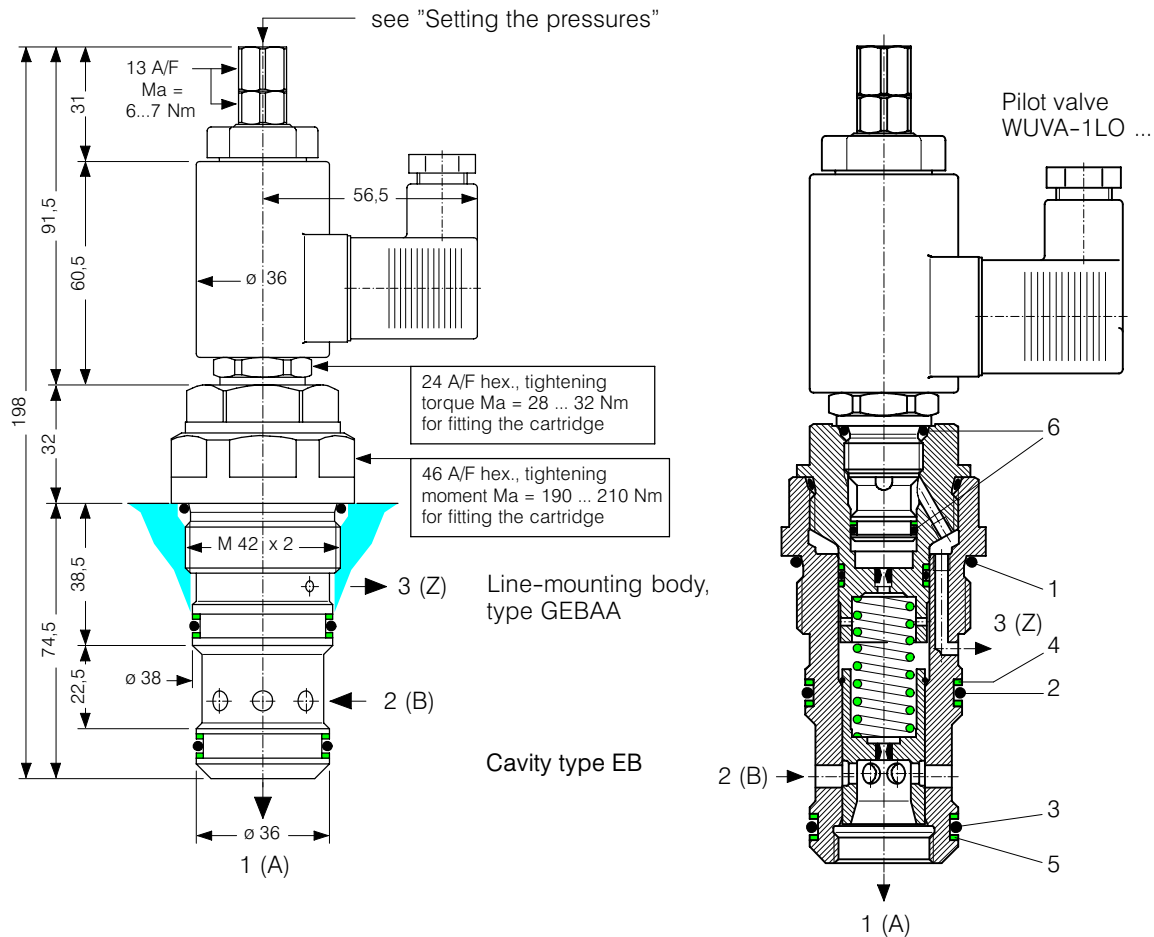

Seal kit no. DS-357, comprising:

| lt. | Qty. | Description | Size |
|-----|------|---------------------------------------|-------------------------|
| 1 | 1 | O-ring no. 129 | Ø 39.34 x 2.62 N90 |
| 2 | 1 | O-ring no. 125 | Ø 32.99 x 2.62 N90 |
| 3 | 1 | O-ring no. 124 | Ø 31.42 x 2.62 N90 |
| 4 | 2 | Backup ring | Ø 32 x 2.0 x 1.4 FI0751 |
| 5 | 2 | Backup ring | Ø 30 x 2.0 x 1.4 FI0751 |
| 6 | 1 | Seal kit no. DS-317 N for WUVA-1LO... | |

7. Installation and servicing

All work must be carried out with care and by qualified personnel only. When fitting the cartridge, ensure that the seals are oiled or greased and use the

specified tightening torque. When changing seals, oil or grease the new seals thoroughly before fitting them.

When fitting the pilot cartridge, ensure that the seals are oiled or greased and use the specified tightening torque.

8. Ordering code

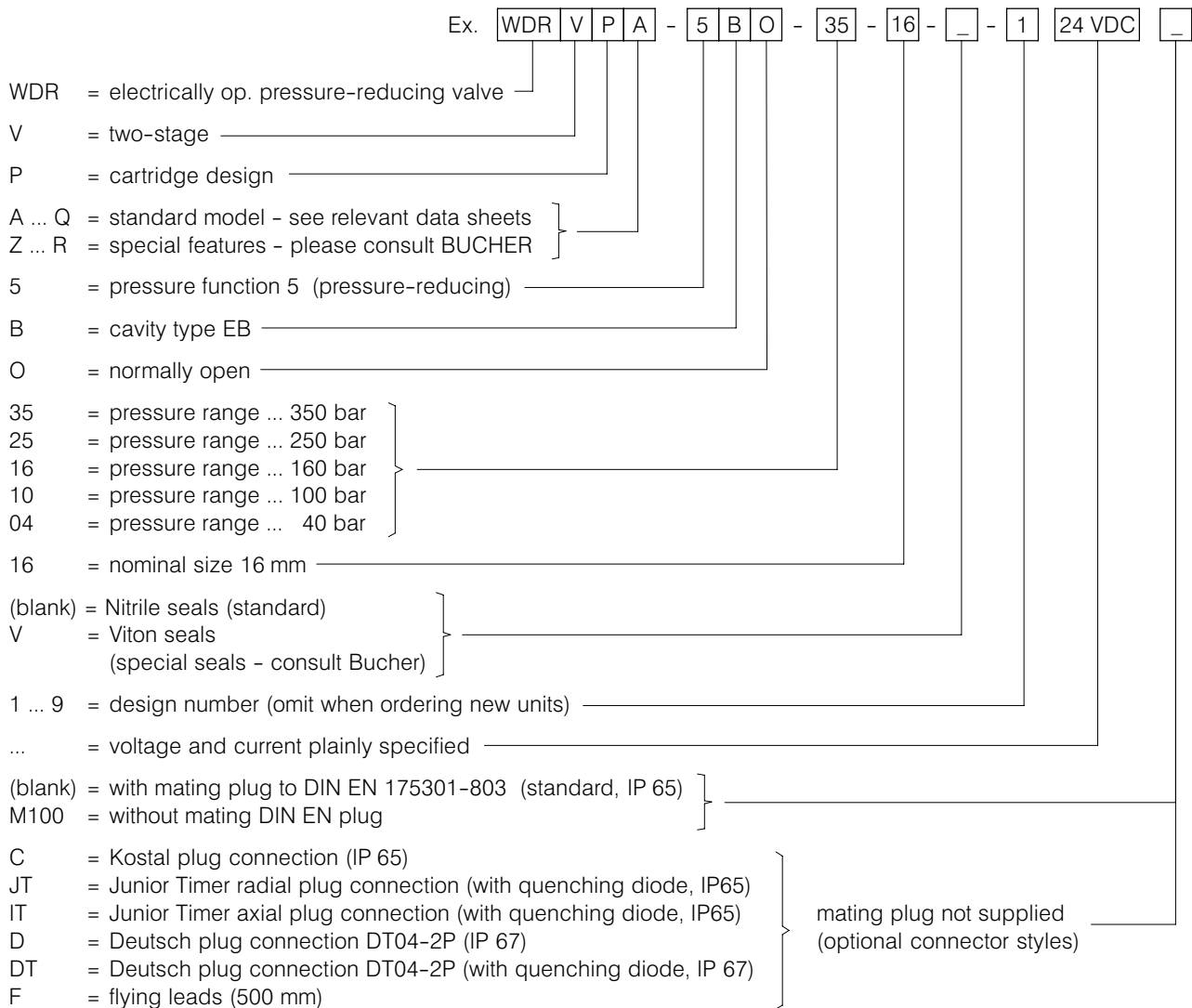

9. Related data sheets

| Old no. | New no. | |
|-----------|----------------|---|
| i - 32 | 400-P-040011-E | The form-tool hire programme |
| i - 55.2 | 400-P-080111-E | Cavity type EB to ISO 7789-42-06-0-07 |
| W - 2.141 | 400-P-120110-E | Coils for screw-in cartridge valves |
| D - 6.10 | 400-P-287101-E | Pilot valve WUVA-1LO... |
| | 400-P-309501-E | Sandwich pressure-reducing valve, ISO size 07, type SWDRVPA-5 ... |
| G - 29.22 | 400-P-750115-E | Line-mounting body type GEBAA (G1") |

BUCHER HYDRAULICS

Germany

Phone +49 7742 85 20
 Fax +49 7742 71 16
 info.de@bucherhydraulics.com

France

Phone +33 389 64 22 44
 Fax +33 389 65 28 78
 info.fr@bucherhydraulics.com

Netherlands

Phone +31 79 34 26 24 4
 Fax +31 79 34 26 28 8
 info.nl@bucherhydraulics.com

UK

Phone +44 24 76 35 35 61
 Fax +44 24 76 35 35 72
 info.uk@bucherhydraulics.com

USA

Phone +1 262 605 82 80
 Fax +1 262 605 82 78
 info.wi@bucherhydraulics.com

www.bucherhydraulics.com

Switzerland

Phone +41 33 67 26 11 1
 Fax +41 33 67 26 10 3
 info.ch@bucherhydraulics.com

Italy

Phone +39 0522 92 84 11
 Fax +39 0522 51 32 11
 info.it@bucherhydraulics.com

Austria

Phone +43 6216 44 97
 Fax +43 6216 44 97 4

China

Phone +86 10 64 44 32 88
 Fax +86 10 64 44 32 35
 info.bj@bucherhydraulics.com

Product Center (Elevator)

Phone +41 41 757 03 33
 Fax +41 41 757 16 49
 info.nh@bucherhydraulics.com

We reserve the right of modification without notice.