

Internal Gear Unit

for motor/pump service
Series QXM

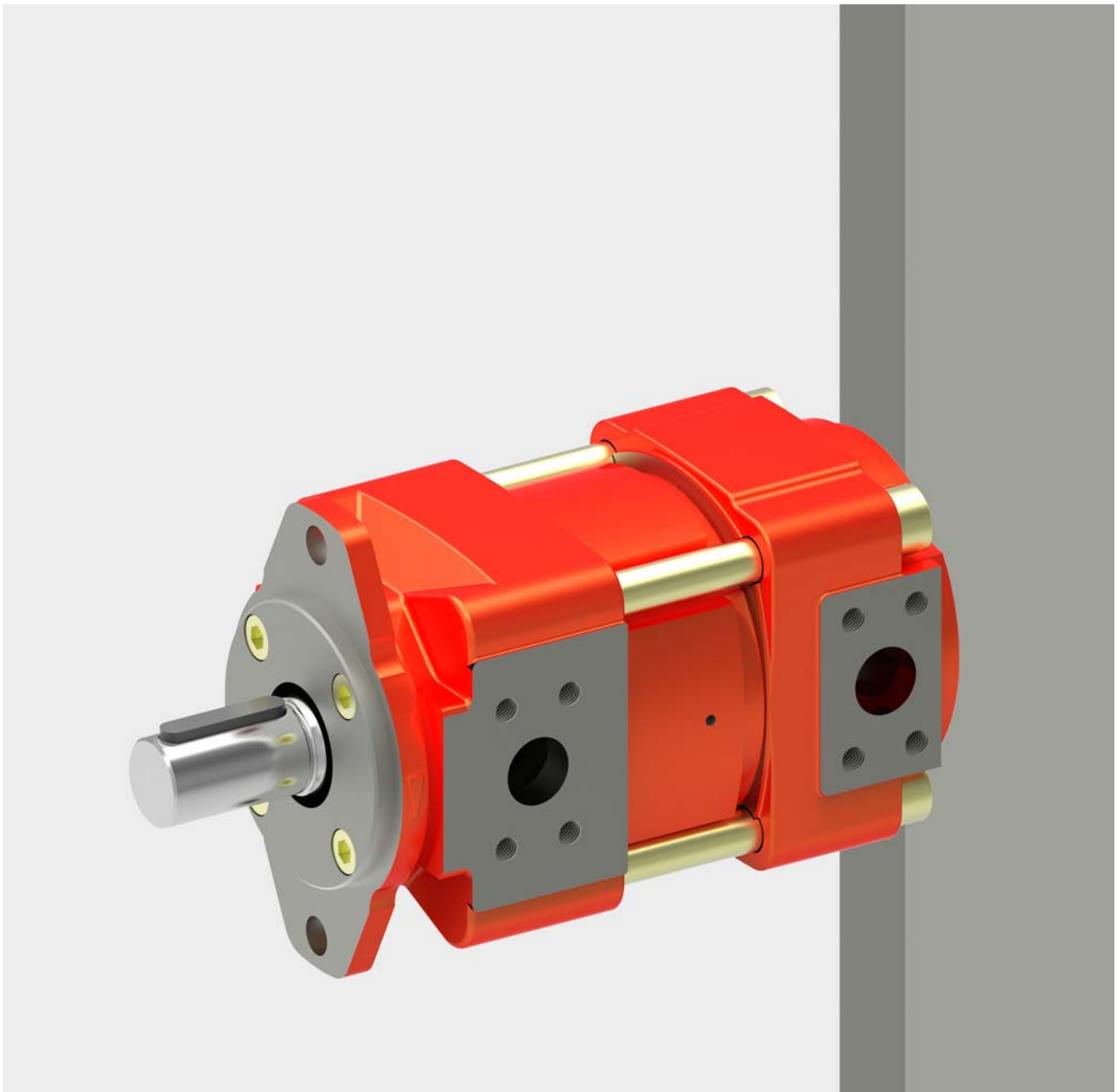

motion and progress

Contents

Page

1	General	3
	1.1 Product description	3
	1.2 Advantages	3
	1.3 Application	3
2	Technical data	3
	2.1 General	3
	2.2 Pressure range 1	4
	2.3 Pressure range 2	5
	2.4 Pressure range 3	6
3	Performance graphs	7
	3.1 Pressure range 1	7
	3.2 Pressure range 2	8
	3.3 Pressure range 3	9
	3.4 Noise level (Lp)	10
4	Dimensions	10
	4.1 Pressure range 1	11
	4.2 Pressure range 2	11
	4.3 Pressure range 3	11
	4.4 Ordering details	12
	4.5 Ordering example	12
	4.6 Standard configuration	12
	4.7 Special features	12
	4.8 Direction of rotation	12
5	Fluid cleanliness	13
6	Note	13
7	Fluid cleanliness	13
8	Operational reliability	13
9	Accessories	14
	9.1 Pipe flanges - high pressure type	14
	9.2 Low pressure type	14
	9.3 Bolt-on valves - SAE J518 code 61 / ISO 6162-1 pattern	15

1 General

1.1 Product description

The QXM drive unit can be used in open- and closed-loop hydrostatic drives, and can operate both as a pump and as a motor.

This flexibility offers possibilities for various applications, one example being the raising and lowering of loads. The QXM works as a pump to lift the load and recovers energy when the load is being lowered.

Used as a fully bi-directional pump/motor (four-quadrant operation), the unit controls a complete motion cycle of a cylinder. Fast acceleration/deceleration sequences can be achieved.

The unit is based on the well-known QX internal gear pump, which is distinguished by its very low noise levels and almost imperceptible pressure pulsations. The large number of closely spaced sizes ensures that the right size is always available for every application.

1.2 Advantages

- very low noise levels
- negligible pressure pulsations
- 400 bar maximum pressure
- long service life
- suitable for special fluids such as HFB, HFC, HFD and bio-degradables
- suitable for variable-speed operation
- 2- and 4-quadrant operation is possible
- optimised flow path cross-sections and special gear profile give low susceptibility to cavitation

1.3 Application

- Injection molding machines
- Hydraulic presses
- Flight simulators
- Wind-power plants
- Lift/elevator drives
- Winches

2 Technical data

2.1 General

Characteristics	Description, value, unit
Installation attitude	unrestricted
Mounting method (standard)	oval 2-hole flange to ISO 3019/1 (SAE): QXM 3-6 oval 2-hole flange to ISO 3019/2 (metric) QXM 2+8
Direction of rotation	unrestricted
Drive method	in-line, by a flexible coupling
Hydraulic fluid	HLP mineral oils to DIN 51524, Part 2 HFB, HFD and HFC fluids to VDMA 24317 other fluids - contact Bucher Hydraulics
Min. fluid cleanliness level	ISO 4406 class 20/18/15, or NAS 1638 class 9
Operating viscosity Starting viscosity	10 to 100 mm ² /s 10 to 300 mm ² /s (higher values, contact Bucher Hydraulics)
Hydraulic fluid temperature	HLP mineral oil - 80°C max. HFB, HFD and HFC 50°C max.
Max. pressure at drain port	1.5 bar absolute (higher values, contact Bucher Hydraulics)
Accumulated pressure restriction	Port P1 + Port P2 ≤ continuous-/intermittent pressure

2.2 Pressure range 1

These operating data are valid for mineral oils with 42 mm²/s

Type	Displacement		minimum Motor Speed [min ⁻¹] ⁵⁾		maximum Speed [min ⁻¹] ³⁾		Operating pressure [bar]		Torque ²⁾ [Nm]
	nominal [cm ³ /U]	effective [cm ³ /U]	Operating pressure on inlet side		Pump operat. ⁴⁾	Motor operating	conti- nous	intermit- tend ¹⁾	
			... 50%	... 100%					
QXM21-010	010	10			4000		160	210	25
QXM21-012	012	12,6	1000	2500	3600	5500	125	160	
QXM21-016	016	15,6			3200		100	125	
QXM31-020	020	20,3			3200		160	210	50
QXM31-025	025	25,1	800	2000	3000	5000	125	160	
QXM31-032	032	32,3			2700		100	125	
QXM41-040	040	39,2			2700		160	210	100
QXM41-050	050	50,5	600	1500	2350	4600	125	160	
QXM41-063	063	63,5			2050		100	125	
QXM51-080	080	80,1			2050		160	210	200
QXM51-100	100	100,9	600	1500	1900	4000	125	160	
QXM51-125	125	124,6			1620		100	125	
QXM61-160	160	162,7			1500		160	210	400
QXM61-200	200	200,9	600	1500	1350	3200	125	160	
QXM61-250	250	248,8			1200		100	125	
QXM81-315	315	326			1200		160	210	800
QXM81-400	400	402,6	600	1200	1100	3000	125	160	
QXM81-500	500	498,5			1000		100	125	

1) Intermittent pressure for max. 20 sec/min but not more than 10% of the duty cycle

2) Theoretical value at the maximum permitted continuous pressure. For starting torques, see section 3.

3) For higher speed contact us

4) Minimum inlet pressure 1 bar absolute

5) Recommended speed. For less speed the pressure must be reducing (linear rate).
For customized working cycle contact Bucher Hydraulics.

2.3 Pressure range 2

These operating data are valid for mineral oils with 42 mm²/s

Type	Displacement		minimum Motor Speed [min ⁻¹] ⁵⁾		maximum Speed [min ⁻¹] ³⁾		Operating pressure [bar]		Torque 2) [Nm]
	nominal [cm ³ /U]	effective [cm ³ /U]	Operating pressure on inlet side		Pump operat. 4)	Motor operating	conti- nous	intermit- tend 1)	
			... 50%	... 100%					
QXM22-005	005	5,1							17
QXM22-006	006	6,3	1650	3000	3250	6000	210	250	21
QXM22-008	008	8,0							26,5
QXM32-010	010	10,0							33,5
QXM32-012	012	12,6	1400	2500	3050	5500	210	250	42
QXM32-016	016	15,6							52
QXM42-020	020	20,3							68
QXM42-025	025	25,1	1000	1800	2900	5000	210	250	84
QXM42-032	032	32,3							108
QXM52-040	040	39,2							131
QXM52-050	050	50,5	1000	1800	2500	4500	210	250	169
QXM52-063	063	63,5							212
QXM62-080	080	80,1							268
QXM62-100	100	100,9	1000	1800	2250	4000	210	250	337
QXM62-125	125	124,6			2050				416
					1800				
QXM82-160	160	162,7			1600				544
QXM82-200	200	200,9	1000	1800	1500	3500	210	250	671
QXM82-250	250	248,8			1350				832

1) Intermittent pressure for max. 20 sec/min but not more than 10% of the duty cycle

2) Theoretical value at the maximum permitted continuous pressure. For starting torques, see section 3.

3) For higher speed contact us

4) Minimum inlet pressure 1 bar absolute

5) Recommended speed. For less speed the pressure must be reducing (linear rate).
For customized working cycle contact Bucher Hydraulics.

2.4 Pressure range 3

These operating data are valid for mineral oils with 42 mm²/s

Type	Displacement		minimum Motor Speed [min ⁻¹] ⁵⁾		maximum Speed [min ⁻¹] ³⁾		Operating pressure [bar]		Torque 2) [Nm]
	nominal [cm ³ /U]	effective [cm ³ /U]	Operating pressure on inlet side		Pump operat. 4)	Motor operating	conti- nous	intermit- tend 1)	
			... 50%	... 100%					
QXM23-005 QXM23-006 QXM23-008	005 006 008	5,1 6,3 8,0	1200	2500	3250	6000	320	400	26 32 41
QXM33-010 QXM33-012 QXM33-016	010 012 016	10,0 12,6 15,6	1000	2000	3050	5500	320	400	51 64 80
QXM43-020 QXM43-025 QXM43-032	020 025 032	20,3 25,1 32,3	750	1500	2900	5000	320	400	103 128 164
QXM53-040 QXM53-050 QXM53-063	040 050 063	39,2 50,5 63,5	750	1500	2500	4500	320	400	200 257 323
QXM63-080 QXM63-100 QXM63-125	080 100 125	80,1 100,9 124,6	750	1500	2250 2050 1800	4000	320	400	408 514 635
QXM83-160 QXM83-200 QXM83-250	160 200 250	162,7 200,9 248,8	750	1500	1600 1500 1350	3500	320	400	828 1023 1267

1) Intermittent pressure for max. 20 sec/min but not more than 10% of the duty cycle

2) Theoretical value at the maximum permitted continuous pressure. For starting torques, see section 3.

3) For higher speed contact us

4) Minimum inlet pressure 1 bar absolute

5) Recommended speed. For less speed the pressure must be reducing (linear rate).
For customized working cycle contact Bucher Hydraulics.

3 Performance graphs

3.1 Pressure range 1

3.1.1 Volumetric efficiency

Measured with $n = 1450 \text{ min}^{-1}$

Viscosity $42 \text{ mm}^2/\text{s}$

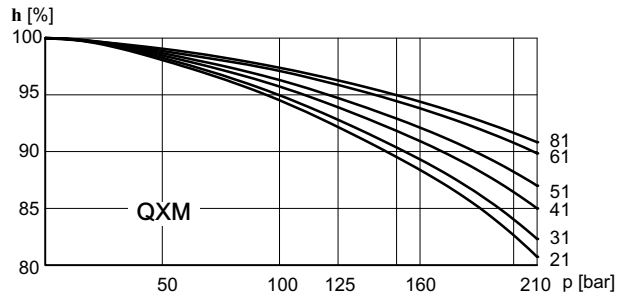

3.1.2 Hydro-mechanical efficiency

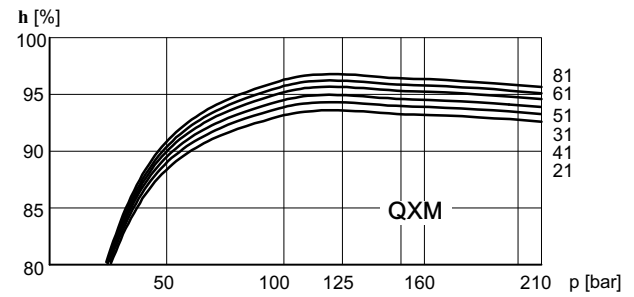

3.1.3 Starting torque

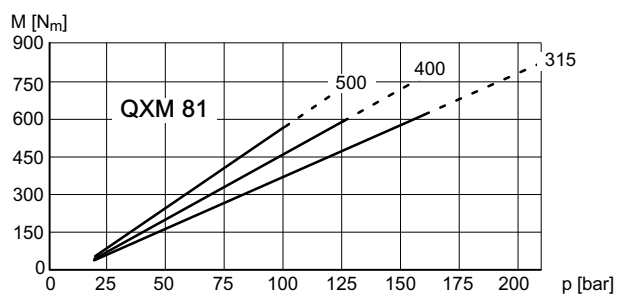
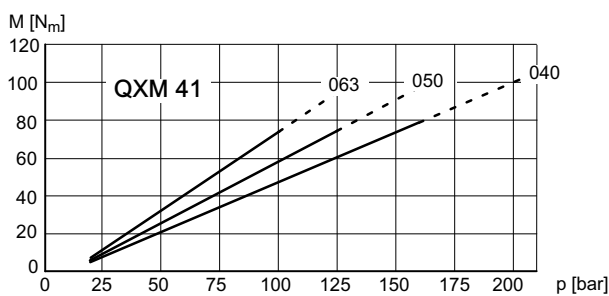
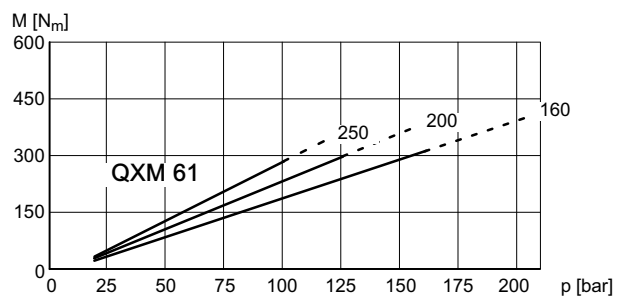
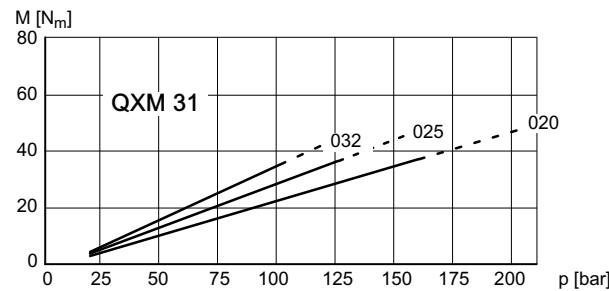
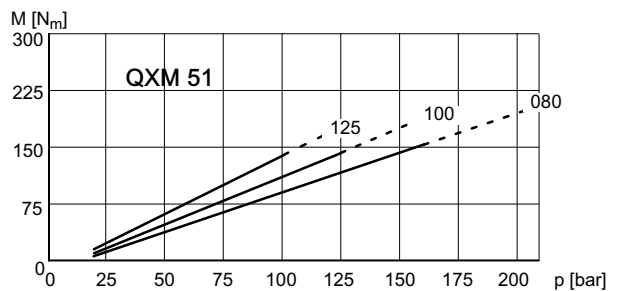
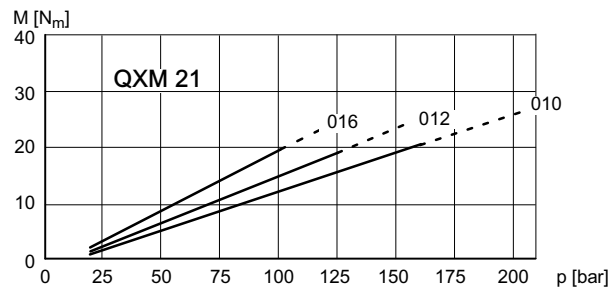

3.1.4 Maximum pressure accumulation at $P_1 + P_2$

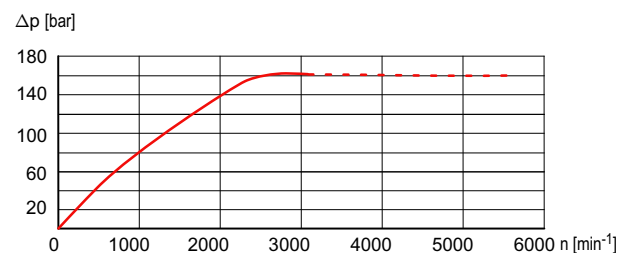

--- = Dependent on frame size (see 2.2)

3.2 Pressure range 2

3.2.1 Volumetric efficiency

Measured with viscosity 42 mm²/s, speed 1450 min⁻¹

Solid line = continuous pressure / dashed line = max. intermittent pressure

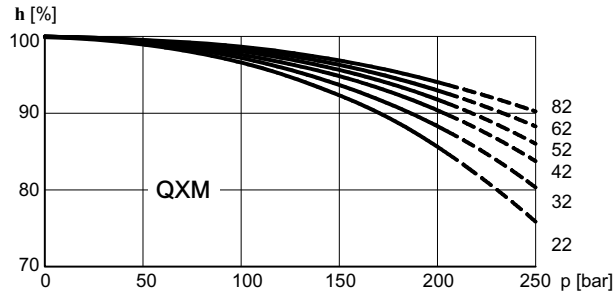

3.2.2 Hydro-mechanical efficiency

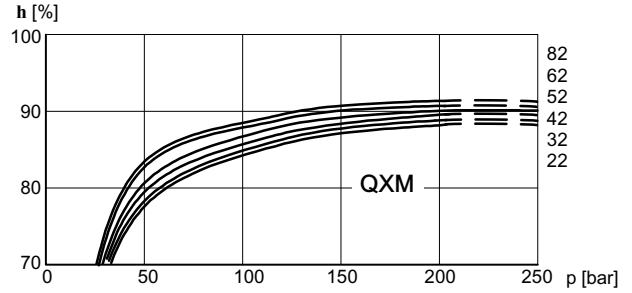

3.2.3 Starting torque

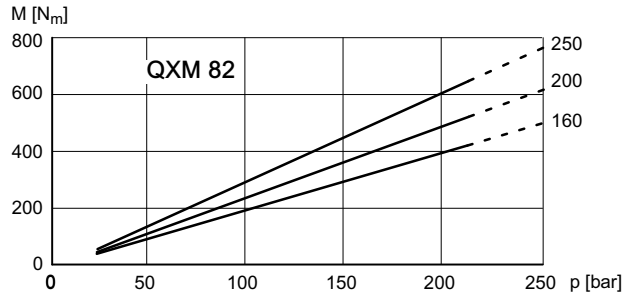
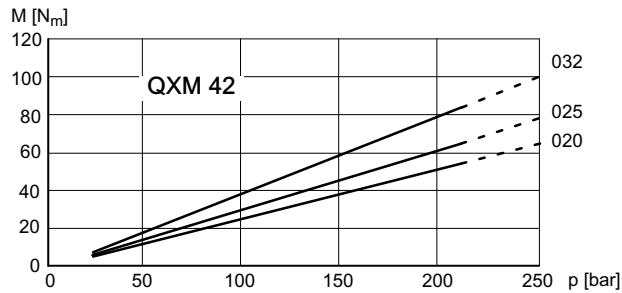
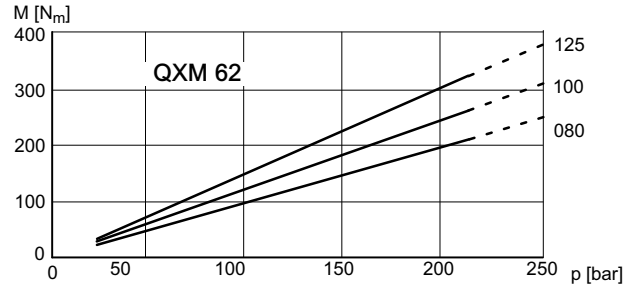
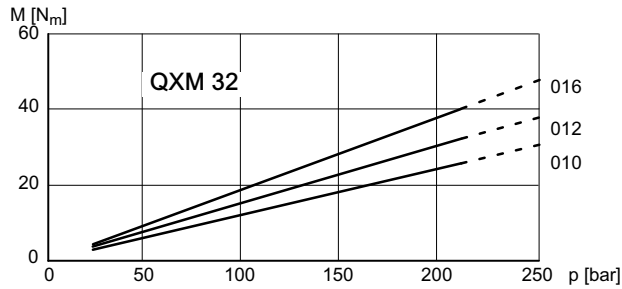
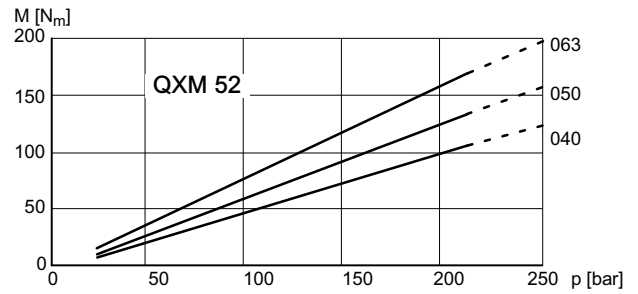
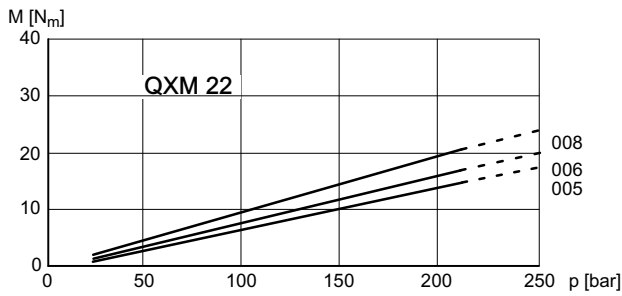

3.2.4 Maximum pressure accumulation at P₁ + P₂

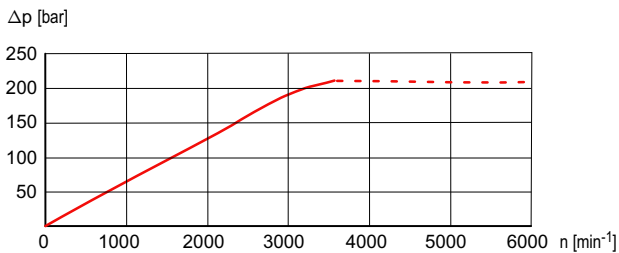

--- = Dependent on frame size (see 2.3)

3.3 Pressure range 3

3.3.1 Volumetric efficiency

Measured with viscosity 42 mm²/s, speed 1450 min⁻¹,
Solid line = continuous pressure / dashed line = max. intermittent pressure

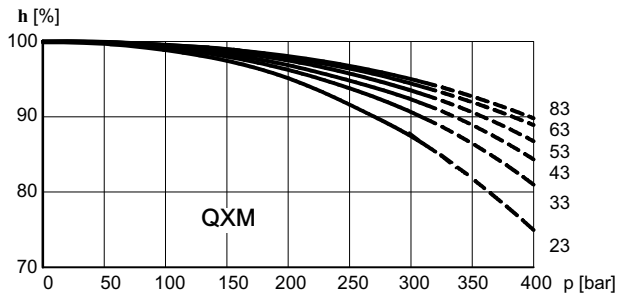

3.3.2 Hydro-mechanical efficiency

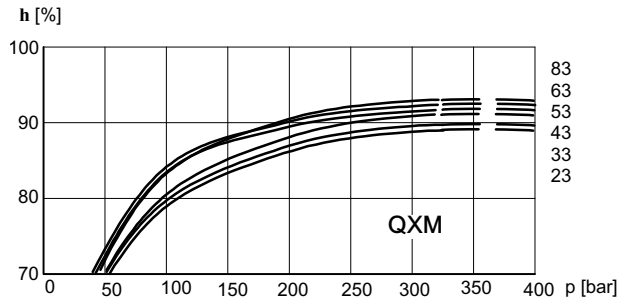

3.3.3 Starting torque

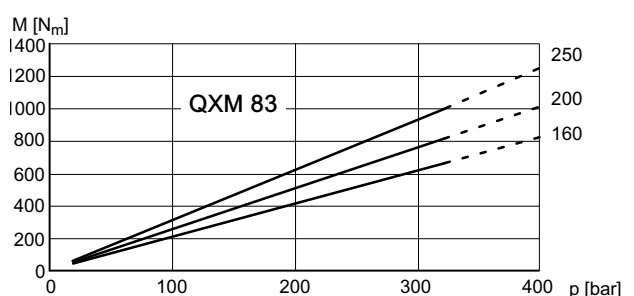
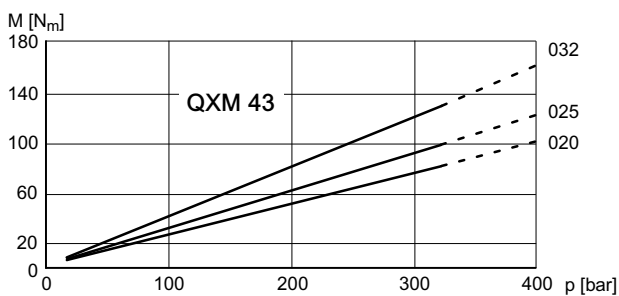
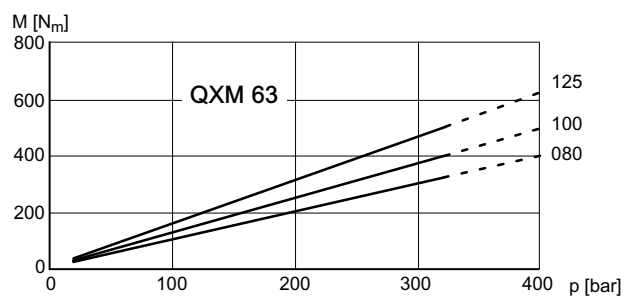
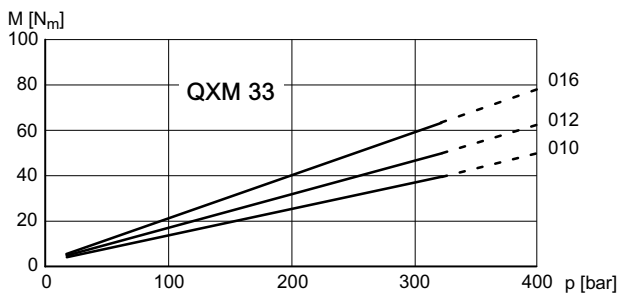
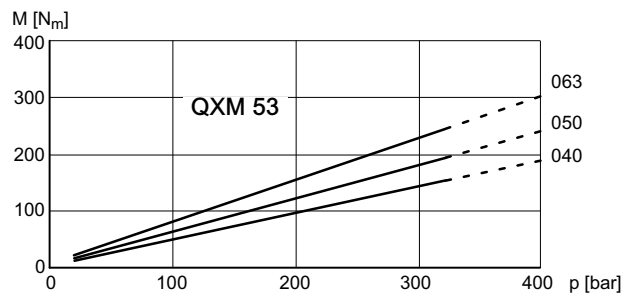
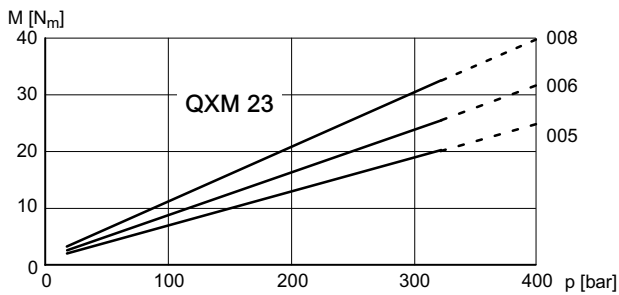

3.3.4 Maximum pressure accumulation at P₁ + P₂

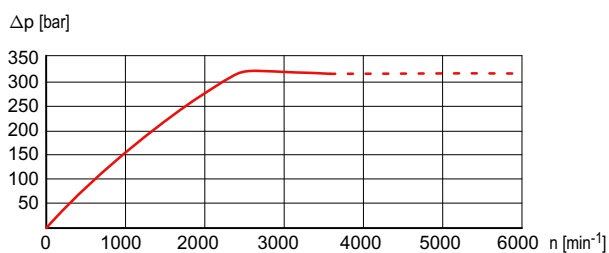

--- = Dependent on frame size (see 2.4)

3.4 Noise level (L_p)

Measured to DIN 45635, Part 26, in Stuttgart University's low-echo noise

Measurement chamber;

Measurement distance 1 m; speed $n = 1500$ rpm; viscosity = 42 mm²/s

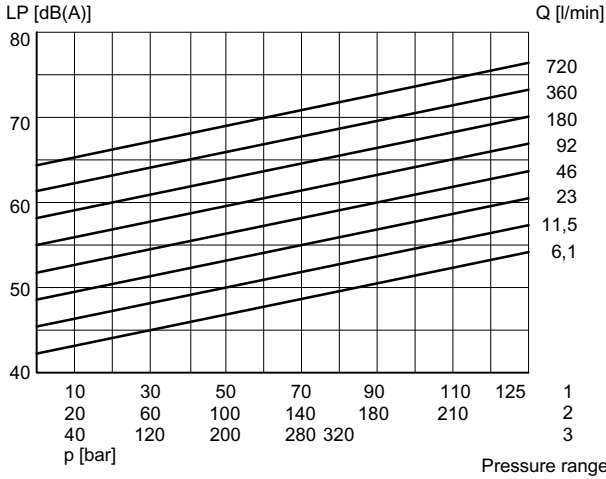

4 Dimensions

Frame size		2			3			4			5			6			8		
Pressure range		1	2	3	1	2	3	1	2	3	1	2	3	1	2	3	1	2	3
Service ports to SAE J518 ¹⁾	P_1, P_2	G1/2" ³⁾ thread			G 3/4" ³⁾ thread			1"			1 1/4"			1 1/2"			2"		
Drain port to DIN 3852 Teil 2 Part 2	P_L	G1/4"			G1/4"			G1/4"			G1/4"			G 3/8"			G1/2"		
Mounting: oval 2-hole flange to ISO 3019/1 (SAE - size 3-6) ISO 3019/2 (Metr. - sizes 2+8)	A	118			132			170			212			267			330		
	$B_{(SAE)}$	-			106			146			181			229			-		
	$B_{(Metr.)}$	100			109			140			180			224			280		
	C	9			11			14			18			22			26		
	$N_{(SAE)}$	-			82,55 - 0,05			101,6 - 0,05			127 - 0,05			152,4 - 0,05			-		
	$N_{(Metr.)}$	63 h8			80 h8			100 - h8			125 h8			160 - h8			200 h8		
Shaft end: parallel, to ISO/R775 ²⁾	O	8,5			8,5			10,5			12,5			16,5			20		
	V	6			6			7			7			7			9		
	D	20 j6			25 j6			32 j6			40 j6			50 j6			63 j6		
	E	36			42			58			82			82			105		
	F	6			8			10			12			14			18		
Housing	G	22,5			28			35			43			53,5			67		
	I	45			50			68			92			92			117		
	K	37,5			44			52,5			60,5			74			90		
	L	140	122	157	166	146	191	204	178	234	244	212	282	289	249	339	364	314	429
	M	-	55	90	-	69,5	114	-	87	143	-	102	172	-	119	209	-	151	266
Weight	T	86			107			133			177			214	220		273	275	
	Z	50			60			62,5			78			97,5			125		

1) For SAE J518 code 61 bzw. ISO6162-1 pipe flange dimensions see section 9

2) For other shaft ends, contact Bucher Hydraulics

3) Threaded ports to DIN 3852 Part 2

4.1 Pressure range 1

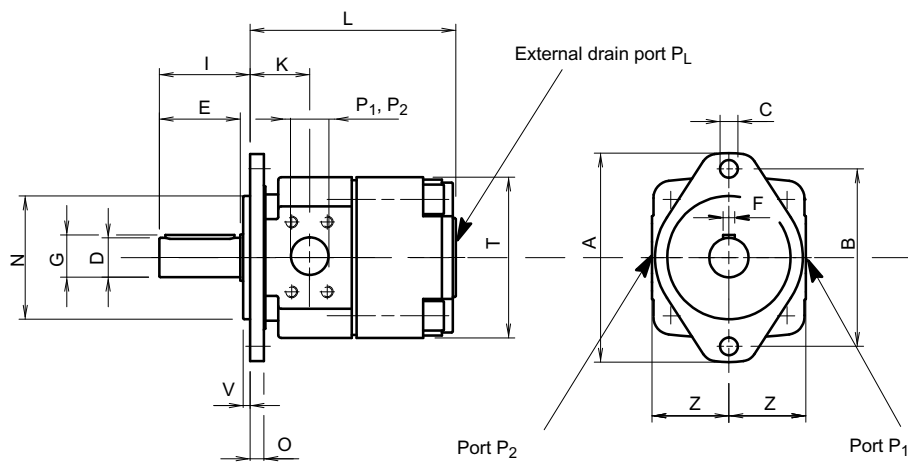

4.2 Pressure range 2

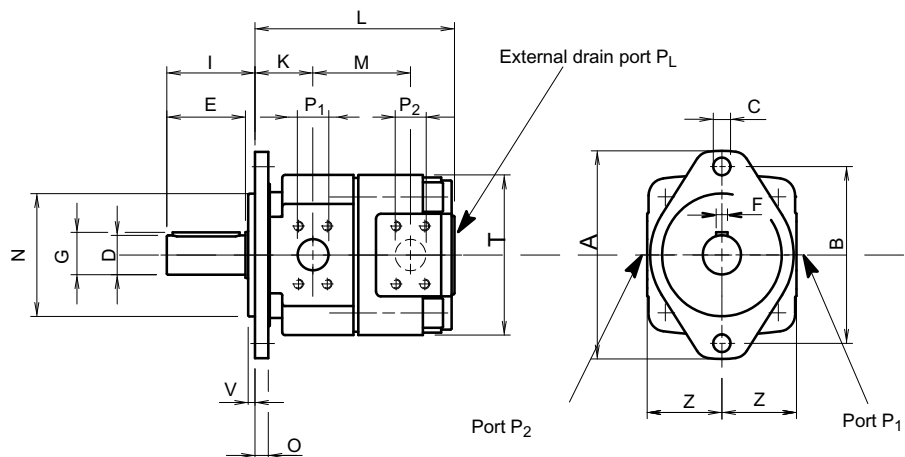

4.3 Pressure range 3

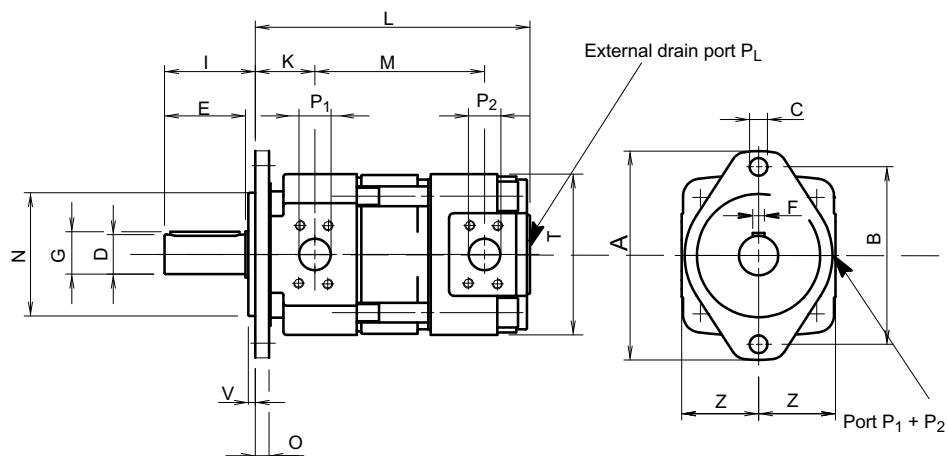

4.4 Ordering details

		Q	X	M	5	3	-	0	4	0	N	*	*	*
Internal gear unit	QXM													
Frame size	2 / 3 / 4 / 5 / 6 / 8													
Pressure range	1 / 2 / 3													
Geom. Displ./Consump. in cm ³ /rev	005 - 500													
Direction of rotation, unrestricted	= N (see section 4.8)													
Variants / special features	(to be inserted by the factory, see section 4.7 for a selection)													

4.5 Ordering example

Required:	internal gear drive unit QXM
Displ./Consump.:	40 cm ³ /rev
Continuous pressure:	300 bar
For use with mineral oil:	HLP
Ordering code:	QXM 53-040 N

4.6 Standard configuration

- Direction of rotation - unrestricted
- 2-hole mounting flange to ISO 3019/1; Frame size QXV 3-6
2-hole mounting flange to ISO 3019/2; Frame size QXV 2+8
- Nitrile seals
- Cylindrical shaft end to ISO R775
- Separate drain port in rear cover of the drive unit
- Ports P1 + P2 both the same size
- Compression proof shaft seal

4.7 Special features

- 09 = Viton seals
 130 = 2-quadrant operation, service port dimensions as per QX pumps
 2-hole mounting flange to ISO 3019/2 (metric)

For other special features, contact Bucher
 Commissioning see Operating Instructions 100-I-000014

4.8 Direction of rotation

Direction of rotation: right
 (clockwise, viewed from the shaft end) = oil flows from P₁ to P₂

Direction of rotation: left
 (counterclockwise, viewed from the shaft end) = oil flows from P₂ to P₁

5 Fluid cleanliness

QXM internal gear units require a fluid with a minimum cleanliness level of NAS 1638, Class 9 or ISO 4406, code 20/18/15.

HLP hydraulic oils to DIN 51524, Part 2, can be used without any special restriction as long as they remain within the specified temperature and viscosity ranges. HFC fire-resistant fluids to DIN 51502 can be used. Note that all fire-resistant fluids require special versions of the pumps or motors and must be approved by Bucher Hydraulics. We recommend the use of fluids that contain anti-wear additives for mixed-friction operating conditions. Fluids without appropriate additives can reduce the service life of pumps and motors. The user is responsible for maintaining, and regularly checking, the fluid quality. Bucher Hydraulics recommends a load capacity of $\geq 30 \text{ N/mm}^2$ to Brugger DIN 51347-2.

6 Note

This catalogue is intended for users with specialist knowledge. The user must check the suitability of the equipment described herein in order to ensure that all of the conditions necessary for the safety and proper functioning of the system are fulfilled. If you have any doubts or questions concerning the use of these pumps, please consult Bucher Hydraulics.

7 Fluid cleanliness

Cleanliness class (RK) as per ISO 4406 and NAS 1638

Code ISO 4406	Dirt particle number / 100 ml			
	$\leq 4 \mu\text{m}$	$\leq 6 \mu\text{m}$	$\leq 14 \mu\text{m}$	NAS 1638
23/21/18	8000000	2000000	250000	12
22/20/18	4000000	1000000	250000	-
22/20/17	4000000	1000000	130000	11
22/20/16	4000000	1000000	64000	-
21/19/16	2000000	500000	64000	10
20/18/15	1000000	250000	32000	9
19/17/14	500000	1300000	16000	8
18/16/13	250000	64000	8000	7
17/15/12	130000	32000	4000	6
16/14/12	64000	16000	4000	-
16/14/11	64000	16000	2000	5
15/13/10	32000	8000	1000	4
14/12/9	16000	4000	500	3
13/11/8	8000	2000	250	2

8 Operational reliability

To ensure a reliable operation and a long service life of the QXM internal gear units, a maintenance schedule must be prepared for the power unit, machine or system. The maintenance schedule must make sure that the provided or permissible operating conditions of the QXM internal gear units are adhered to over the period of use.

In particular, compliance with the following operating parameters must be ensured:

- The required oil cleanliness
- The operating temperature range
- The fluid level

Moreover, the QXM internal gear units and the system must be inspected at regular intervals for changes in the following parameters:

- Vibration
- Noise
- Differential temperature of internal gear unit – fluid in the tank
- Foaming in the tank
- Freedom from leakage

Changes in these parameters indicate wear of components (e.g. drive motor, coupling, internal gear unit, etc.). The cause must be immediately pinpointed and eliminated.

To provide high operational reliability of the QXM internal gear unit in the machine or system, we recommend continuous, automatic checks of the above parameters and an automatic shutdown in the case of changes that exceed the usual fluctuations within the provided operating range.

9 Accessories

9.1 Pipe flanges - high pressure type

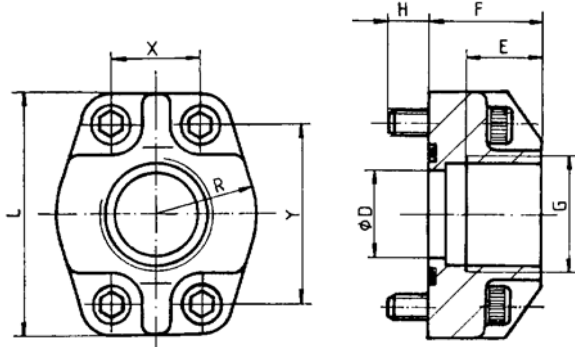

- Max. operating pressure 420 bar
- Flange size SAE J518 code 61 / ISO 6162-1

Threaded pipe flanges are spot-faced for DIN 2353 pipe fittings
Material: ST37 / For Viton seals, contact Bucher Hydraulics

Ordering-number	Ordering code	Size	DØ	E	F	H	L	R	X	Y	Viton seal 90 Shore 'A'	Retaining screws DIN912-12.9 / Torque Nm	
037000	RF 01-R08	G 1/2"	12,5	16	27	13	54	23	17,5	38	20,24x2,62	M8x30	30
037010	RF 02-R10	G 3/4"	20	18	30	12	65	26	22,2	47,6	26,65x2,62	M10x30	60
037020	RF 03-R11	G 1"	25	20	34	13	70	29	26,2	52,4	32,99x2,62	M10x35	60
037030	RF 04-R12	G 1 1/4"	32	22	38	14	80	36	30,2	58,6	40,86x3,53	M10x40	60
037040	RF 05-R13	G 1 1/2"	38	24	41	19	94	41	35,7	70	44,04x3,53	M12x45	120
037050	RF 06-R14	G 2"	50	26	45	20	102	48	42,9	77,8	59,92x3,53	M12x50	120
055470*	RF 07-R16	G 2 1/2" *	63	30	50	18	114	57	50,8	89	72,62x3,53	M12x45	120

* At RF07 only to 210 bar be allowed

9.2 Low pressure type

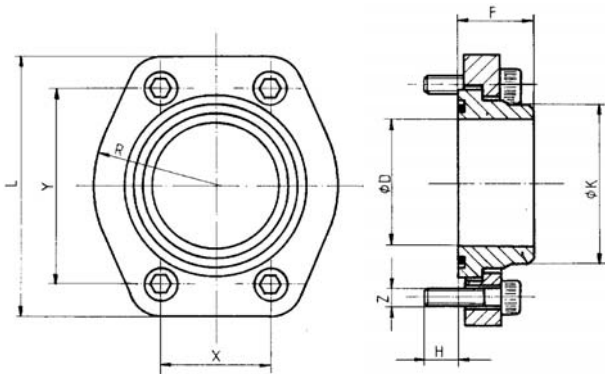

- Max. operating pressure 16 bar
- Flange size SAE J518 code 61 / ISO 6162-1

Material: ST37 / For Viton seals, contact Bucher Hydraulics

Ordering number	Ordering code	SAE flange Size	D	K	F	H	L	R	X	Y	Viton seal 90 Shore 'A'	Retaining screws DIN 912-8.8 Torque Nm		pipe ¹⁾ O/dia. approx.
062450	RN 07-S	2 1/2"	63	75	35	14	120	57	51	89	69,44x3,53	M12 x 30	70	75
063880	RN 08-S	3"	76	88			140,5	68	62	106,5	85,32x3,53	M16 x 40	180	88
063890	RN 09-S	3 1/2"	89	100	40	19	158,5	73	70	120,3	98,02x3,53	M16 x 40	180	100
063900	RN 10-S	4"	103	115			168	79	78	130	110,72x3,53	M16 x 40	180	115

1) We recommend the use of seamless precision steel tube to DIN 2391 with-wallthick. max 6 mm

9.3 Bolt-on valves - SAE J518 code 61 / ISO 6162-1 pattern

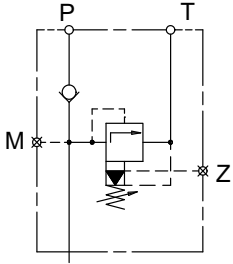
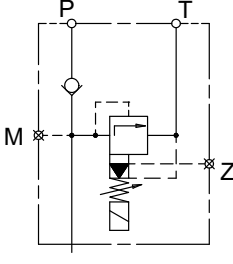
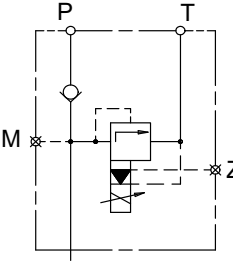
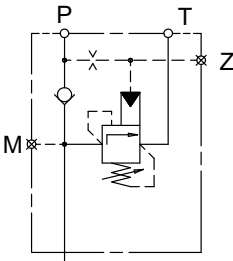
Ordering details	Pressure relief $A_G^S DF / A_G^S DH$	Pressure relief solenoid control $A_G^S DA / ASDM$	Pressure relief proportional solenoid control $A_G^S DP$
Symbols			
Ordering details	Unloading valve Accumulator charging valve $A_G^S AF$ $A_G^S SF$		
Symbols			<p>S = For pipe flange SAE J518 code 61 pattern (all size)</p> <p>G = With threaded port, G 1" (size QX2, 3)</p>

For other informations on Bolt-on valves see data sheet 100-P-000119

info.kl@bucherhydraulics.com

www.bucherhydraulics.com

© 2012 by Bucher Hydraulics GmbH, D-79771 Klettgau

All rights reserved.

Data is provided for the purpose of product description only, and must not be construed as warranted characteristics in the legal sense. The information does not relieve users from the duty of conducting their own evaluations and tests. Because the products are subject to continual improvement, we reserve the right to amend the product specifications contained in this catalogue.

Classification: 420.245. 200