

B-2

MEDIUM VOLTAGE CABLES

**RUBBER
INSULATION**

Engineering Data for
Copper and Aluminium
Conductors

Cables design	page	2
Introduction		3
Technical standards		
Key cables code		
Cables marking		
Electrical metallic conductors		4
Metal conductor replacement		5
Electrical insulation stress		
Special performance cables		6
Alternative kind cables		7
Metallic armour cables		8
AWG calculation		
Quality System		9
Conditions for current ratings		
Selection cables for alternative current system		
Range and dimension	1.8/3 kV	10-11
Range and dimension	3.6/6 kV	12-13
Range and dimension	6/10 kV	14-15
Range and dimension	8.7/15 kV	16-17
Range and dimension	12/20 kV	18-19
Range and dimension	15/20 kV	20-21
Range and dimension	18/30 kV	22-23
Range and dimension	26/45 kV	24-25
Apparent electric resistance of the conductor		26
Capacity values		
Phase reactance values		27
Group rating factors		28-29
Electrical formulas		30
Final tests		31
Storage and handling		32
Installation		32-33
Packaging		33-34
Glossary		35

SINGLE CORE CABLE

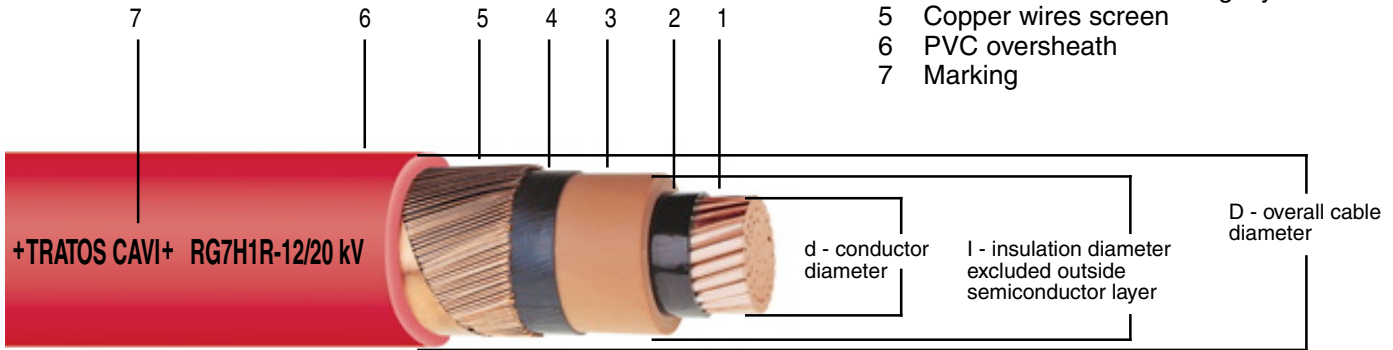

- 1 Copper or aluminium circular stranded compacted conductor
- 2 Extruded semi-conducting lay
- 3 HEPR insulation
- 4 Extruded semi-conducting layer
- 5 Copper wires screen
- 6 PVC oversheath
- 7 Marking

THREE CORES CABLE

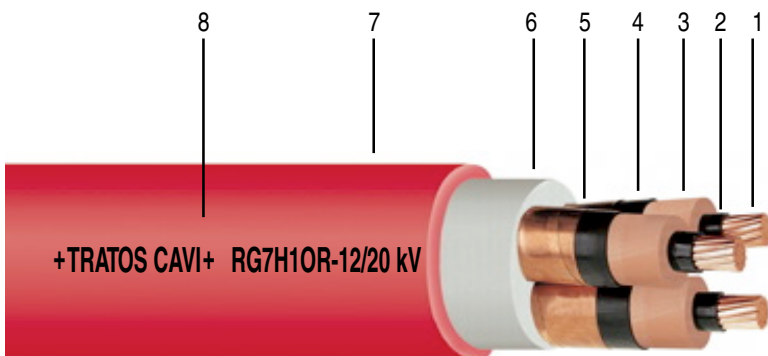

- 1 Copper circular stranded compacted conductor
- 2 Extruded semi-conducting layer
- 3 HEPR insulation
- 4 Extruded semi-conducting layer
- 5 Copper tapes screen
- 6 Not hygroscopic filler
- 7 PVC oversheath
- 8 Marking

THREE CORES ARMoured CABLE

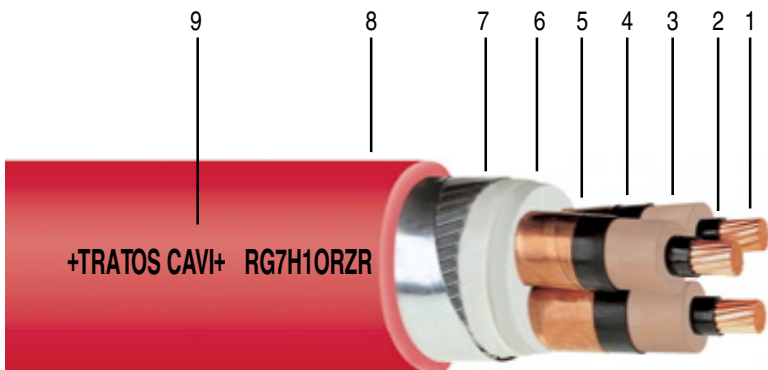

- 1 Copper or aluminium circular stranded conductor
- 2 Extruded semi-conducting layer
- 3 HEPR insulation
- 4 Extruded semi-conducting layer
- 5 Copper tapes screen
- 6 Not hygroscopic filler
- 7 Galvanized steel flat wire armour
- 8 PVC oversheath
- 9 Marking

INTRODUCTION TO MEDIUM VOLTAGE CABLES

This booklet is designed to help engineers in the selection of conductors sizes and in the installation of cables system.

The information provide general cross sectional area, outside diameter, weight, bending radius and handling cables. Besides you can select the ampacity of a cable and the various factors given for any installation condition varying from those for which the tables where calculated.

Basic data has been calculated in compliance of the conditions as **page 9**.

Furthermore detailed information may be requested directly to our customer's assistance service office. Please to take into consideration many alternative kind cables with special performances as described on **pages 4, 5, 6, 7 and 8**.

We are available to produce cables with AWG conductors size, as shown on **page 8**, to employ by end-user operating out from metric-system area.

TECHNICAL STANDARDS

CEI 20-13	Rubber insulated cables with rated voltages between 1 kV and 30 kV U _o /U (U _m) 1.8/3(3.6) 3.6/6(7.2) kV 6/10(12) kV 8.7/15(17.5) kV 126/20(24) kV 18/30(36) kV
CEI 20-66	Power cables with extruded insulation for rated voltage above 30 kV (U _m 42 kV) up to 150 kV (U _m 170 kV) U _o /U (U _m) 26/45(52) kV
CEI 20-29	Conductor of insulated cables
EN 50265	Test for vertical flame propagation for single insulated conductor or cable
CEI 20-21	Calculation of the current rating
CEI 11-17	Generation, trasmission and distribution systems of electric power - Cables installation

KEY CABLES CODE

A	Aluminium conductor	O	Mean three phases under the same outersheath
R	Conductor class 2 (without any lettere before R mean copper conductor)	A	Steel braid armour
E4	XLPE polyethylene insulation	AH6	Corrugated aluminium tape electrowelded
G7	HEPR high ethylene propylene rubber insulation	H6	Corrugated steel tape electrowelded
H1	Tapes or wires copper screen	H9	Corrugated steel tape thermosealed
H5	Longitudinally thermosealed aluminium tape	Z	Flat steel wires armour
R	PVC - polyvinyl chloride sheath	N	Steel tapes armour
E	Polyethylene sheath	NA	Aluminium tapes armour
M1	LS0H - low smoke zero halogen compound	F(SWA)	Steel wires armour
		FA(AWA)	Aluminium wires armour
		X	Mean three single sheathed cables assembled together

CABLES MARKING

In order to provide the cable type identification , cable-maker and generally its traceability in compliance of **Quality Guarantee** rules, any cables has an entire code continually printed or engraved or embossed on the outer-sheath.

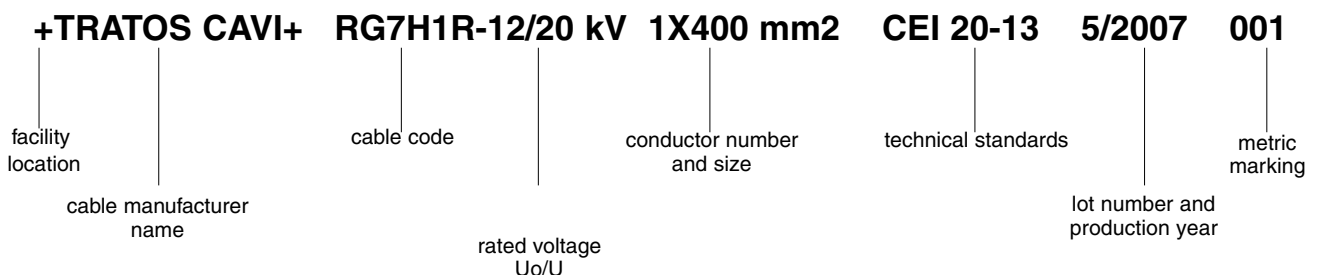

Copper and aluminum are the most employed metals for conductors in the cables power production technology. Their application is due to different parameters as electric conductivity, density (mass per unit volume), breaking load and elongation, malleability, thermal conductivity, elastic module and finally metal cost-effective. The shape of conductors and their rigidity or flexibility is designed in consideration of the final application and of the rated voltage cable.

For medium tension cable is very important a smooth outside surface metal conductor to reduce electrical insulation stress. For the purpose any MT conductor is compacted by special tools suitable to calibrate outside diameter and surface. In all tables we report the nominal cables section expressed in mm² but the real conductor size considered is defined **Electrical Section** that is guaranteed by means of check of the maximum appropriate electrical resistance at 20°C in compliance of technical standards.

- 1- class 2 round stranded not compacted
- 2- class 2 round stranded compacted
- 3- class 5 uniform bunched wires
- 4- class 2 round compacted water blocking
- 5- class 1 round solid
- 6- class 1 shaped solid
- 7- class 1 shaped stranded

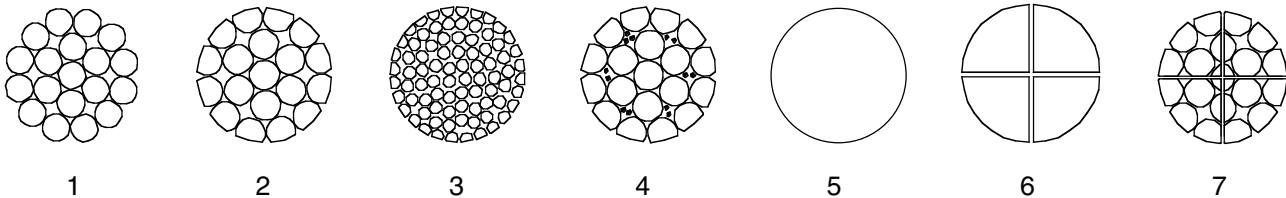

METAL CHARACTERISTICS

When is necessary to improve a few basic metal characteristics is possible to lose or reduce significant other properties. However typical metal characteristics ordinary way contemplated, over any global evaluation, are indicated in the table below.

Copper results to hold the greatest electrical conductivity but despite that its price may be still high if compared with aluminium for example. Following information help you a fully technical evaluation.

CHARACTERISTICS	UNITS	ANNEALED COPPER	HARD COPPER	ALUMINIUM (3/4 HARD)	ALUMINIUM ALLOY	LEAD	STEEL
code		Cu-ETP		Al 99.5			
chemical symbol		Cu	Cu	Al	-	Pb	Fe
density	Kg/dm ³	8.89	8.89	2,7	2.7	11.35	7.8
resistivity at 20°C	Ohm.km/mm ²	17.241	17.586	28.264	32.50	206	190
electric conductivity	% IACS*	100	98	61	53	8.4	9
thermal conductivity	W/cm.k	3.893	3.893	2.218	1.84	0,35	0.46
breaking load	daN/mm ²	20-30	35-50	12-15	35-40	1.75	40-150
breaking elongation	%	25-30	0.5-3	1.5-3	4-6	20-50	2-6
elastic module	daN/mm ²	10500	12000	5600	6000	1700	18500
melting temp.	°C	1083	1083	657	657	327	1400
specific heat	Cal/°C.g	0.093	0.093	0.214	0.214	0.030	0.114
temp. variation coef.	k-1	0.00393	0.00393	0.00403	0.0036	0.0042	0.004
linear dielectric coef.	k-1 (x 10 ⁻⁶)	17	17	23	23	29	11.5

* International Annealed Copper standard

METAL CONDUCTOR REPLACEMENT

Strictly connected to metal market price an important save money may be achieved by to use aluminium cables instead of copper cables. In this case a calculation of aluminium conductor size, bigger than copper, is possible by electrical equivalence formula:

Cu resistivity	0.017241 Ohm • mm ² /m at 20° C	= 0.61
Al resistivity	0.028264 Ohm • mm ² /m at 20° C	

Due to the above equivalence how to change an aluminium cable in a copper cable and contrariwise:

example

Al cable size 240 mm² • 0.61 = 146.40 mm² Cu (mathematical size)
consequently the nearest available standard size to use is **150 mm² Cu**

Cu cable size 240 mm² : 0.61 = 393.44 mm² Al (mathematical size)
consequently the nearest available standard size to use is **400 mm² Al**

ELECTRICAL INSULATION STRESS

The HEPR insulation is extruded simultaneously with the conductor screen and the insulation screen. The surfaces between inner semiconductor layer and HEPR insulation and between insulation and outside semiconductor layer are not exposed to environment conditions. Triple steam or dry curing extrusion guarantee high products quality. Is known that the electrical stress is maximum at the conductor level surface and decrease drawing up outside insulation layer.

In order to avoid stress peak in the medium voltage cable compacted metallic conductors with homogeneous and smooth surface are employed. Besides that the extruded conductor screen allows an uniform electric field which contributes for a long duration cable life.

The insulation thickness may be calculated by following formula.

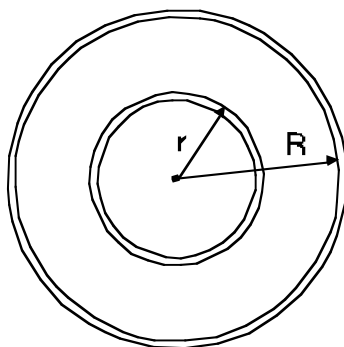

$$E_x = \frac{U_0}{x \ln(R/r)} \text{ kV/mm}$$

- R** radius under insulation screen
- r** radius over conductor screen
- U₀** voltage across insulation

INSULATION STRESS VALUE example 18/36 kV

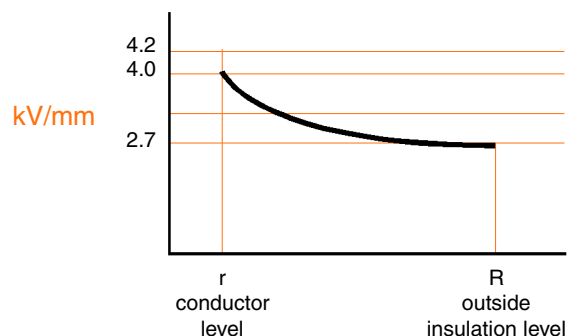

FLAME RETARDANT - LOW SMOKE - ZERO HALOGENS (LS0H)

Fire is one of the most danger for popolations and equipments especially inside structures and in any place where it may happen. Very frequently that is due to the very extensive use of cables. They can be an important components to trigger fire, carry flames everywhere, developping acid gasses and dark fumes very hazardous for persons.

In consideration of past tragic happenings have been developped special cables with particular performances reaction to fire as to design cables with components able to avoid issue aggressive substances underburnings event without loosing or altering any basic feature.

Flame Retardancy - cables in compliance of standards country regualtions suitable to overcome special restrict propagation test on single cable or bunched cables with definite volium per meter of non metallic material. Its behaviour is strictly related to the combustion quantity material exposed to the flame, temperature and aeration.

Corrosivity Combustion Gasses - not LS0H during combustion develop great quantities of corrosive and toxic gasses. New generation cables reduce or entirely remove it.

Intensity and Dark Smoke - under fire conditions not LS0H cables release dark smokes that prevent people evacuation, that has been restricted ta lot, as a special test able to verify residue light across the smokes shows.

EN 50265 Test for resistance to vertical flame propagation for a single insulated conductor or cable
IEC 60332-1

EN 50266 Test for vertical flame spread of vertically-mounted bunched wires or cables
IEC 60332-3

EN 50267 Test on gases evolved during combustion of materials from cables
IEC 60754

EN 61034 Measurement of smoke density of cables burning under defined conditions
IEC 61034

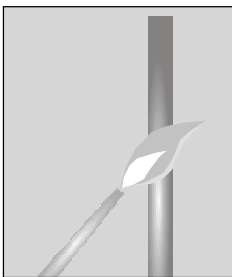

EN 50265
IEC 60332-1



EN 50266
IEC 60332-3

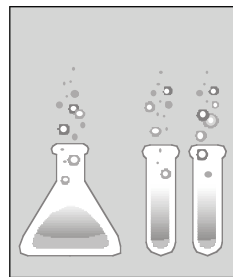

EN 50267
IEC 60754

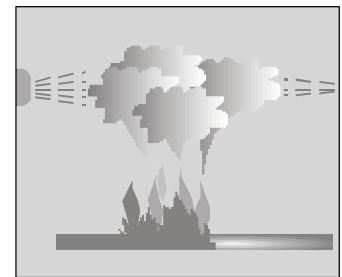

EN 61034
IEC 61034

Alternative kinds of cable are possible to be engineered in order to ensure a long term service with large tolerability for specific working conditions as dry and wet ground, rain and snow, under-water without any cover, direct exposition to the sun, places where cables can be crashed into etc.

Electromagnetic Fields (EMF) are one of the most technical matters that affect environment condition that may be supervised by an appropriate increase of the cable metallic screen.

- 1- Particularly eligible for installations in contact with water and moisture contact thanks to longitudinally thermosealed aluminium tape screen absolute safety of transverse tightness.
- 2- In any habitat place where a limited a EMF level is required we provide through the electrical balance of conductor and cable screen.
- 3- **Root Cable** is a commercial brand cable in aluminium or copper conductor with a non metallic mechanical protection made-up of an under outsheath plastic layer able to cushion heavy blow and to safeguard the below metallic cable screen.

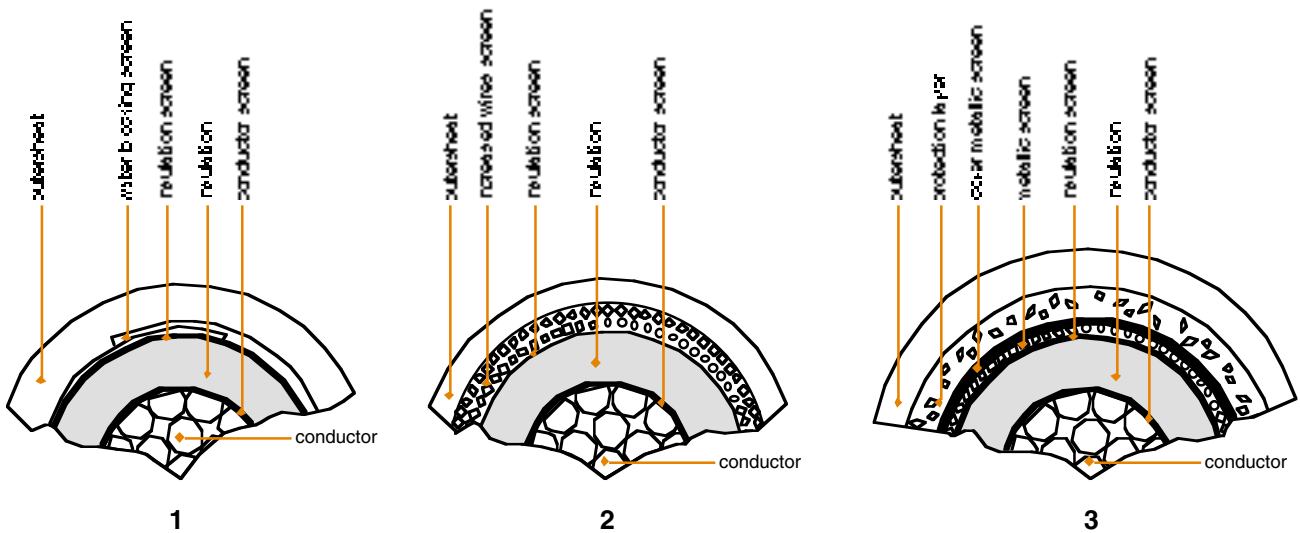

- 4- Self supporting cables for overhead installations through aluminium steel cladding rope laid in the central of three single phases. That rope can be replaced with a non metallic rope. This involves a new cable design with an increase screen size to allow electrical current fault discharge.
- 5- Three-phases underground cable with additional cables service.
- 6- Composite MT and FO cable where three-phases power elements and telecommunication aggregate fiber optic cable able to work under the same outsheath.

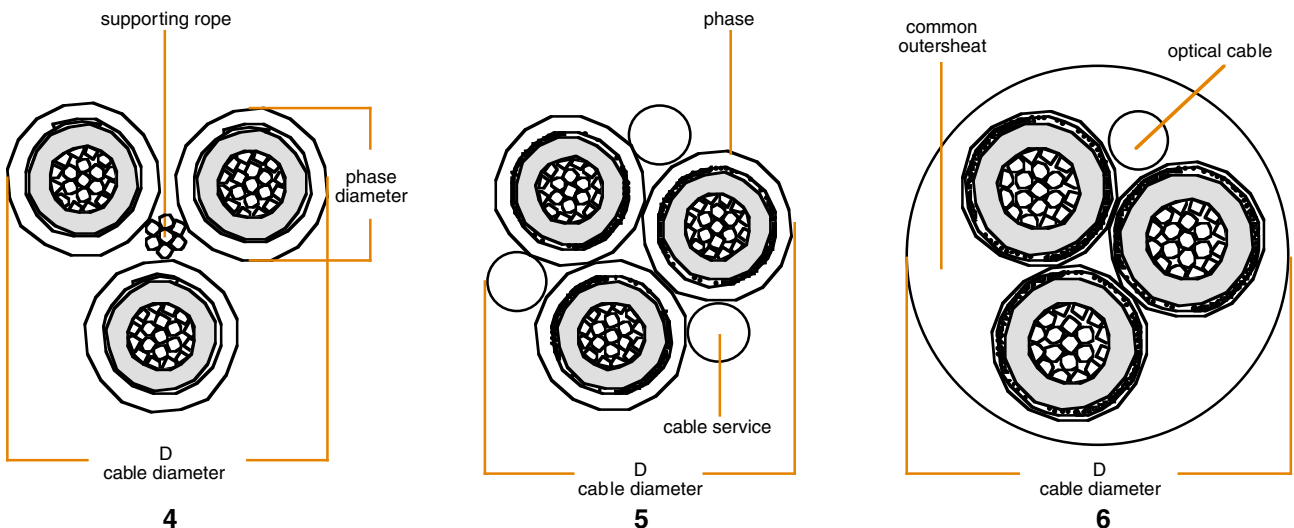

METALLIC ARMOUR CABLES

A few different types of armour can be designed as protection of cables against crabs ,blow, shock, cuts, abrasions etc. Furthermore in order to avoid electrical induction in the single phase cables the armour must be made-up of non-magnetic metals as copper, aluminium, bronze etc..

Steel braid armour - a few group of wires braided together in opposite way.

Wires armour - a layer of round wires.

Tapes armour - double tapes wrapped in the same direction in open helics, the second one to cover underlyings space.

Corrugated armour - a single longitudinally smooth tape corrugated by a special tool.

Flat wires armour - a layer of wrapped flat wires with a contrary tape wrapped in open helics.



A steel braid armour

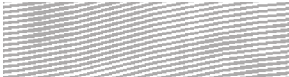

F (SWA) a layer of wrapped steel round wires
FA (AWA) a layer of wrapped aluminium round wires



N double steel tapes wrapped in open helics, the second one to cover underlyings space
NA double aluminium tapes wrapped in open helics, the second one to cover underlyings space



AH6 longitudinally overlapping corrugate aluminium tape
H6 longitudinally overlapping corrugate steel tape electrowelded
H9 longitudinally overlapping corrugate steel tape thermosealed



Z a layer of wrapped steel flat wires with a contrary steel tape wrapped in open helics

AWG CALCULATION

For any operator in a market where there is in force AWG system the following table can be used to turn mm² to AWG or CM and contrariwise. Please keep in consideration some ineluctable approximate calculation due to standard metric system size.

Approximate parallel square-mm to AWG					AWG reference	Conversion AWG to square-mm				
Stand. size mm ²	Elec. resist. Ohm/km 20°C Cu	Elec. resist. Ohm/km 20°C Al	CM (circ.mil)	approx. diam. mil *		approx. diam. mil *	CM (circ.mil)	Elec. resist. Ohm/km 20°C Cu	Elec. resist. Ohm/km 20°C Al	Stand. size mm ²
10	1.83	3.08	19735	162.3	8 AWG	148.4	16510	3.68	2.19	8.366
16	1.15	1.91	31576	205.2	6 AWG	187.1	26251	2.29	1.38	13.302
25	0.727	1.20	49338	256.6	4 AWG	236.0	41741	1.418	0.859	21.151
35	0.524	0.868	69073	303.6	2 AWG	297.6	66371	0.903	0.545	33.631
50	0.387	0.641	98676	362.8	1 AWG	334.1	83693	0.756	0.456	42.408
70	0.268	0.443	138147	429.3	3/0 AWG	473.1	167806	0.365	0.220	85.029
95	0.193	0.320	187485	500.1	4/0 AWG	531.3	211600	0.283	0.171	107.219
120	0.153	0.253	236823	562.1	5/0 AWG	596.6	266823	0.224	0.136	135.219
150	0.124	0.206	296029	628.4	6/0 AWG	670.0	336457	0.181	0.109	170.485
185	0.0991	0.164	365102	697.9	7/0 AWG	752.3	424265	0.141	0.0852	214.978
240	0.0754	0.125	473646	794.9	8/0 AWG	844.8	534988	0.111	0.0667	271.082
300	0.0601	0.100	592058	888.7	9/0 AWG	948.7	674607	0.0877	0.0527	341.829
400	0.0470	0.0778	789410	1026.2	10/0 AWG	1065.3	850664	0.0721	0.0436	431.038
500	0.0366	0.0605	986763	1147.3	11/0 AWG	1196.2	1072668	0.0556	0.0336	543.529
630	0.0283	0.0469	1243321	1287.9	12/0 AWG	1343.3	1352609	0.0431	0.0260	685.377
800	0.0221	0.0367	1578820	1451.3	13/0 AWG	1508.4	1705608	0.0339	0.0205	864.244
1000	0.0176	0.0291	1973525	1622.6	14/0 AWG	1693.9	2150732	0.0267	0.0161	1089.792
1200	0.0151	0.0247	2368230	1777.4	15/0 AWG	1902.1	2712023	0.0216	0.0132	1374.202
1400	0.0129	0.0212	2762935	1919.9	15/0 AWG	1902.1	2712023	0.0216	0.0132	1374.202
1600	0.0113	0.0186	3157640	2052.4	16/0 AWG	2135.9	3419798	0.0171	0.0104	1732.837
1800	0.0101	0.0165	3552345	2176.9	16/0 AWG	2135.9	3419798	0.0171	0.0104	1732.837
2000	0.0090	0.0149	3947050	2294.7	17/0 AWG	2398.5	4312286	0.0136	0.0082	2185.068

*stranded conductor

Our Quality System management includes two certificates:

Basec (UK) and **Aenor** (E), in accordance to ISO 9001 covering the production, purchasing of raw materials, design and final test including various document typologies.

Tratos Quality System management is under constant control by auditing inspectors.

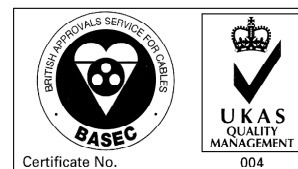

CONDITIONS FOR CURRENT RATINGS

Current ratings values stated in the following schedules have been calculated in compliance with IEC 60287 standard.

Current ratings values refer to the following conditions:

Conductor maximum temperature	90° C
Ambient temperature for installation in open air	30° C
Ambient temperature for underground installation	20° C

Laying depths

mt. 0.8	for voltages	U = 3.0÷10kV
mt. 1.0	for voltages	U = 15÷30kV
mt. 1.2	for voltages	U = 45kV

Thermal resistivity (R_t)

ground	100 and 200° C · cm/W
HEPR insulation	450° C · cm/W
PVC oversheath	500° C · cm/W

The metallic screen (6 mm² standard size), jointed together, are connected to earth.

SELECTION OF CABLES FOR ALTERNATIVE CURRENT SYSTEM

Three-phases system characteristics				Insulation rating cables	
nominal tension U (kV)	maximum tension Um (kV)	class	maximum time for each test with grounded phase*	with screen on the single core U ₀ (kV)	without screen on the single-core U ₀ /U kV
3	3.6	B	over 8 h	1.8	1.8/3
6	7.2	A	up to 8 h	3.6	3.6/6
		B	over 8 h	6	–
10	12	A	up to 8 h	6	–
		B	over 8 h	8.7	–
15	17.5	A	up to 8 h	8.7	–
		B	over 8 h	12	–
20	24	A	up to 8 h	12	–
		B	over 8 h	15	–
30	36	A	up to 8 h	18	–
		B	over 8 h	26	–
45	52	A	up to 8 h	26	–
		B	over 8 h	30	–

U₀ = relates to the nominal tension between a conductor and earth
 U = relates to the nominal tension between the conductors of the cable
 Um = maximum tension for which the cable is suitable

* The whole annual period must be established in consideration of the environmental conditions

SINGLE-CORE RG7H1R-1.8/3 kV - ARG7H1R-1.8/3 kV

nominal area conductor mm ²	conductor diameter d mm.	insulation thickness mm.	nominal overall diameter D mm.	maximum overall diameter mm.	approximate cable weight kg/km		minimum bending radius mm.
					Cu	Al	
1x 10	3.8	2.0	11.8	13.8	252	–	170
1x 16	4.8	2.0	12.8	14.8	327	–	180
1x 25	6.0	2.0	14.4	16.4	443	–	210
1x 35	7.0	2.0	15.4	17.4	553	–	220
1x 50	8.2	2.0	17.0	19.0	722	422	240
1x 70	9.9	2.0	19.2	21.2	957	537	270
1x 95	11.5	2.0	20.8	22.8	1212	641	290
1x120	12.9	2.0	22.2	24.2	1461	741	310
1x150	14.2	2.0	24.0	26.0	1765	864	340
1x185	16.2	2.0	25.6	27.6	2118	1008	360
1x240	18.2	2.0	28.0	30.0	2654	1214	395
1x300	21.2	2.0	30.5	32.5	3259	1460	430
1x400	23.4	2.0	34.0	36.0	4207	1808	480
1x500	27.3	2.2	38.0	40.0	5222	2223	540
1x630	30.5	2.4	41.5	43.5	6457	2679	580

THREE-CORES RG7H10R-1.8/3 kV - ARG7H10R-1.8/3 kV

nominal area conductor mm ²	conductor diameter d mm.	insulation thickness mm.	nominal overall diameter D mm.	maximum overall diameter mm.	approximate cable weight kg/km		minimum bending radius mm.
					Cu	Al	
3x 10	3.8	2.0	24.2	26.2	965	–	340
3x 16	4.8	2.0	26.0	28.0	1220	–	370
3x 25	6.0	2.0	28.5	30.5	1576	–	400
3x 35	7.0	2.0	30.7	32.7	1954	–	430
3x 50	8.2	2.0	33.3	35.3	2486	1586	470
3x 70	9.9	2.0	37.1	39.1	3231	1971	530
3x 95	11.5	2.0	41.6	43.6	4165	2452	580
3x120	12.9	2.0	44.6	46.6	5010	2850	630
3x150	14.2	2.0	48.8	50.8	6117	3417	680
3x185	16.2	2.0	52.7	54.7	7359	4029	740
3x240	18.2	2.0	58.5	60.5	9288	4968	820
3x300	21.2	2.0	64.2	66.2	11338	5941	900
3x400	23.4	2.0	70.4	72.4	14551	7354	990
3x500	27.3	2.2	80.5	82.5	18308	9311	1130

ARMOURED THREE-CORES RG7H10ZR-1.8/3 kV - ARG7H10ZR-1.8/3 kV

nominal area conductor mm ²	conductor diameter d mm.	insulation thickness mm.	nominal overall diameter D mm.	maximum overall diameter mm.	approximate cable weight kg/km		minimum bending radius mm.
					Cu	Al	
3x 10	3.8	2.0	27.5	30.0	1323	–	387
3x 16	4.8	2.0	29.9	32.4	1633	–	420
3x 25	6.0	2.0	32.8	35.3	2066	–	562
3x 35	7.0	2.0	35.0	37.5	2478	–	492
3x 50	8.2	2.0	38.4	40.9	3269	2369	539
3x 70	9.9	2.0	42.8	45.3	4170	2910	602
3x 95	11.5	2.0	46.6	49.1	5156	3443	654
3x120	12.9	2.0	49.8	52.3	6101	3941	699
3x150	14.2	2.0	54.2	56.7	7310	4610	760
3x185	16.2	2.0	58.0	60.5	8643	5313	814
3x240	18.2	2.0	62.9	65.4	10685	6365	882
3x300	21.2	2.0	69.8	72.3	12920	7523	980
3x400	23.4	2.0	74.9	77.4	16240	9043	1050
3x500	27.3	2.2	85.7	88.2	20385	11388	1201

CONTINUOUS CURRENT RATINGS (ampere)

nominal area conductor	ground laying								air laying			
	R _t =100 °C cm/W				R _t =200 °C cm/W							
	mm ²	Cu ... Al	Cu .. Al	Al	Cu ... Al	Cu .. Al	Al	Al	Cu ... Al	Cu .. Al	Al	Al
1x 10	103	–	97	–	78	–	72	–	113	–	89	–
1x 16	135	–	124	–	102	–	96	–	142	–	117	–
1x 25	172	–	160	–	130	–	121	–	191	–	150	–
1x 35	206	–	190	–	152	–	141	–	230	–	180	–
1x 50	240	187	228	176	180	139	170	130	277	215	220	169
1x 70	292	230	277	215	218	172	206	161	347	270	275	216
1x 95	352	278	330	258	258	206	247	192	425	330	337	262
1x120	400	314	377	296	292	230	279	218	487	383	392	306
1x150	444	352	420	330	328	260	308	243	551	433	445	347
1x185	502	398	475	372	370	292	349	270	632	501	516	402
1x240	580	461	549	433	426	337	402	318	746	591	617	482
1x300	651	521	621	490	479	380	452	358	856	686	710	559
1x400	736	596	701	561	542	437	510	409	991	800	825	657
1x500	831	676	790	641	606	493	576	462	1141	937	952	765
1x630	930	765	883	724	676	557	642	552	1302	1068	1100	898

CONTINUOUS CURRENT RATINGS (AMPERE)

nominal area conductor	ground laying				air laying	
	R _t =100 °C cm/W		R _t =200 °C cm/W			
	mm ²	Cu	Al	Cu	Al	Cu
3x 10	93	–	72	–	85	–
3x 16	119	–	93	–	108	–
3x 25	154	–	118	–	145	–
3x 35	186	–	140	–	176	–
3x 50	217	168	166	130	208	160
3x 70	266	208	203	158	264	204
3x 95	316	246	238	185	319	248
3x120	360	280	272	210	368	286
3x150	400	312	306	236	412	325
3x185	452	354	345	270	472	374
3x240	520	408	398	312	556	438
3x300	583	461	445	352	638	502
3x400	652	522	498	398	718	575
3x500	733	593	560	454	820	660

CONTINUOUS CURRENT RATINGS (AMPERE)

nominal area conductor	ground laying				air laying	
	R _t =100 °C cm/W		R _t =200 °C cm/W			
	mm ²	Cu	Al	Cu	Al	Cu
3x 10	88	–	70	–	80	–
3x 16	115	–	88	–	104	–
3x 25	146	–	113	–	136	–
3x 35	173	–	136	–	167	–
3x 50	205	161	160	125	200	154
3x 70	254	198	194	152	248	193
3x 95	300	236	233	181	302	236
3x120	343	268	264	206	350	274
3x150	383	300	296	230	396	312
3x185	435	339	333	262	454	356
3x240	506	394	386	302	540	422
3x300	566	446	434	342	615	487
3x400	644	510	493	391	714	566
3x500	729	576	560	443	824	651

SINGLE-CORE RG7H1R-3.6/6 kV - ARG7H1R-3.6/6 kV

nominal area conductor	conductor diameter d	insulation thickness	nominal overall diameter D	maximum overall diameter	approximate cable weight kg/km		minimum bending radius
					Cu	Al	
mm ²	mm.	mm.	mm.	mm.			mm.
1x 10	3.8	3.0	15.4	17.4	380	–	210
1x 16	4.8	3.0	16.3	18.3	458	–	230
1x 25	6.0	3.0	17.9	19.9	591	–	240
1x 35	7.0	3.0	18.9	20.9	705	–	260
1x 50	8.2	3.0	20.5	22.5	894	594	280
1x 70	9.9	3.0	22.2	24.2	1116	696	310
1x 95	11.5	3.0	23.8	25.8	1381	810	340
1x120	12.9	3.0	25.2	27.2	1644	924	370
1x150	14.2	3.0	27.0	29.0	1659	1059	380
1x185	16.2	3.0	29.0	31.0	2335	1225	400
1x240	18.2	3.0	31.4	33.4	2909	1469	440
1x300	21.2	3.0	34.4	36.4	3525	1726	480
1x400	23.4	3.0	36.6	38.6	4468	2069	510
1x500	27.3	3.2	41.2	43.2	5531	2532	570
1x630	30.5	3.2	44.5	46.5	6778	3000	620

THREE-CORES RG7H10R-3.6/6 kV - ARG7H10R-3.6/6 kV

nominal area conductor	conductor diameter d	insulation thickness	nominal overall diameter D	maximum overall diameter	approximate cable weight kg/km		minimum bending radius
					Cu	Al	
mm ²	mm.	mm.	mm.	mm.			mm.
3x 10	3.8	3.0	31.2	33.2	1490	–	437
3x 16	4.8	3.0	33.3	35.3	1767	–	468
3x 25	6.0	3.0	35.9	38.0	2182	–	504
3x 35	7.0	3.0	38.0	40.0	2585	–	532
3x 50	8.2	3.0	41.2	43.2	3236	2336	578
3x 70	9.9	3.0	45.0	47.0	4044	2748	632
3x 95	11.5	3.0	48.7	50.7	4993	3280	983
3x120	12.9	3.0	52.1	55.0	5948	3788	731
3x150	14.2	3.0	55.3	58.3	7113	4413	776
3x185	16.2	3.0	59.8	62.8	8334	5004	839
3x240	18.2	3.0	64.5	67.5	10248	5928	905
3x300	21.2	3.0	71.4	74.4	12536	7139	1000
3x400	23.4	3.0	76.7	79.7	15758	8561	1075
3x500	27.3	3.2	86.6	89.6	19628	10631	1215

ARMOURED THREE-CORES RG7H10ZR-3.6/6 kV - ARG7H10ZR-3.6/6 kV

nominal area conductor	conductor diameter d	insulation thickness	nominal overall diameter D	maximum overall diameter	approximate cable weight kg/km		minimum bending radius
					Cu	Al	
mm ²	mm.	mm.	mm.	mm.			mm.
3x 10	3.8	3.0	35.0	37.0	1946	–	492
3x 16	4.8	3.0	37.9	40.4	2486	–	532
3x 25	6.0	3.0	41.1	43.6	3018	–	577
3x 35	7.0	3.0	43.2	45.7	3472	–	606
3x 50	8.2	3.0	46.2	48.7	4166	3266	648
3x 70	9.9	3.0	50.3	52.8	5088	3828	706
3x 95	11.5	3.0	54.1	56.6	6135	4422	459
3x120	12.9	3.0	57.5	60.0	7156	4996	807
3x150	14.2	3.0	61.8	64.3	8401	5701	867
3x185	16.2	3.0	65.6	68.1	9752	6422	920
3x240	18.2	3.0	72.1	74.6	11795	7475	1012
3x300	21.2	3.0	76.8	79.3	14192	8795	1077
3x400	23.4	3.0	84.5	87.0	17610	10413	1185
3x500	27.3	3.2	95.2	97.7	21600	12603	1334

CONTINUOUS CURRENT RATINGS (ampere)

nominal area conductor	ground laying								air laying			
	R _t =100 °C cm/W				R _t =200 °C cm/W							
	mm ²	Cu ... Al	Cu .. Al	Al	Cu ... Al	Cu .. Al	Al	Al	Cu ... Al	Cu .. Al	Al	Al
1x 10	101	–	94	–	78	–	71	–	107	–	89	–
1x 16	130	–	124	–	98	–	92	–	138	–	111	–
1x 25	164	–	157	–	124	–	120	–	179	–	148	–
1x 35	196	–	186	–	152	–	140	–	219	–	184	–
1x 50	235	180	222	170	178	137	168	132	263	208	222	169
1x 70	287	222	269	210	217	168	203	157	330	259	272	213
1x 95	342	267	323	252	258	203	243	190	402	317	336	260
1x120	390	304	370	287	291	232	274	216	465	368	390	304
1x150	432	342	413	324	327	258	308	242	525	417	442	346
1x185	490	387	470	366	368	291	344	272	606	482	516	400
1x240	568	450	542	424	424	335	402	315	714	565	610	479
1x300	642	511	612	480	475	379	452	355	820	655	702	552
1x400	727	584	693	552	536	430	512	406	950	764	815	647
1x500	820	667	769	632	602	493	574	465	1102	829	940	757
1x630	914	751	874	717	668	557	641	528	1265	1035	1085	882

CONTINUOUS CURRENT RATINGS (ampere)

nominal area conductor	ground laying				air laying	
	R _t =100 °C cm/W		R _t =200 °C cm/W			
	mm ²	Cu	Al	Cu	Al	Cu
3x 10	95	–	72	–	87	–
3x 16	120	–	94	–	112	–
3x 25	154	–	119	–	146	–
3x 35	185	–	140	–	178	–
3x 50	217	169	166	130	210	164
3x 70	264	206	203	158	264	205
3x 95	315	245	242	188	320	250
3x120	358	280	275	215	370	288
3x150	398	312	306	240	415	326
3x185	452	354	346	270	477	372
3x240	518	408	397	312	556	438
3x300	584	460	446	352	637	502
3x400	652	520	502	398	719	572
3x500	736	593	562	455	824	664

CONTINUOUS CURRENT RATINGS (ampere)

nominal area conductor	ground laying				air laying	
	R _t =100 °C cm/W		R _t =200 °C cm/W			
	mm ²	Cu	Al	Cu	Al	Cu
3x 10	82	–	68	–	78	–
3x 16	106	–	85	–	101	–
3x 25	137	–	111	–	130	–
3x 35	164	–	133	–	156	–
3x 50	194	152	156	120	189	146
3x 70	240	186	190	147	234	182
3x 95	286	222	226	176	286	222
3x120	327	256	257	200	330	257
3x150	364	285	286	224	370	290
3x185	412	322	324	256	426	335
3x240	477	374	377	296	501	394
3x300	541	425	423	335	576	456
3x400	616	488	480	383	666	530
3x500	701	560	544	436	770	614

SINGLE-CORE RG7H1R-6/10 kV - ARG7H1R-6/10 kV

nominal area conductor mm ²	conductor diameter d mm.	insulation thickness mm.	nominal overall diameter D mm.	maximum overall diameter mm.	approximate cable weight kg/km		minimum bending radius mm.
					Cu	Al	
1x 10	3.8	3.4	17.6	19.6	473	–	250
1x 16	4.8	3.4	18.6	20.6	560	–	265
1x 25	6.0	3.4	20.2	22.2	699	–	290
1x 35	7.0	3.4	21.2	23.2	821	–	300
1x 50	8.2	3.4	22.4	24.4	973	653	316
1x 70	9.9	3.4	24.0	26.0	1219	799	340
1x 95	11.5	3.4	25.7	27.7	1495	924	365
1x120	12.9	3.4	27.5	29.5	1787	1067	390
1x150	14.2	3.4	28.9	30.9	2079	1179	408
1x185	16.2	3.4	30.9	32.9	2472	1362	440
1x240	18.2	3.4	33.8	35.8	3051	1611	480
1x300	21.2	3.4	35.8	37.8	3643	1844	510
1x400	23.4	3.4	38.0	40.0	4611	2212	550
1x500	27.3	3.4	42.3	44.3	5681	2682	590
1x630	30.5	3.4	45.5	47.5	6876	3093	650

THREE-CORES RG7H10R-6/10 kV - ARG7H10R-6/10 kV

nominal area conductor mm ²	conductor diameter d mm.	insulation thickness mm.	nominal overall diameter D mm.	maximum overall diameter mm.	approximate cable weight kg/km		minimum bending radius mm.
					Cu	Al	
3x 10	3.8	3.4	34.9	36.9	1898	–	490
3x 16	4.8	3.4	37.1	39.1	2244	–	520
3x 25	6.0	3.4	40.1	42.1	2729	–	562
3x 35	7.0	3.4	42.4	44.4	3210	–	595
3x 50	8.2	3.4	45.4	47.4	3861	2961	637
3x 70	9.9	3.4	49.1	51.1	4702	3442	690
3x 95	11.5	3.4	52.9	54.9	5744	4031	742
3x120	12.9	3.4	56.3	58.3	6722	4562	790
3x150	14.2	3.4	59.1	61.1	7885	5185	830
3x185	16.2	3.4	64.0	66.0	9304	6000	898
3x240	18.2	3.4	68.7	70.7	11392	7072	963
3x300	21.2	3.4	75.5	77.5	13650	8253	1059
3x400	23.4	3.4	81.1	83.1	17151	9954	1138
3x500	27.3	3.4	89.5	91.5	20926	11929	1255

ARMOURED THREE-CORES RG7H10ZR-6/10 kV - ARG7H10ZR-6/10 kV

nominal area conductor mm ²	conductor diameter d mm.	insulation thickness mm.	nominal overall diameter D mm.	maximum overall diameter mm.	approximate cable weight kg/km		minimum bending radius mm.
					Cu	Al	
3x 10	3.8	3.4	40.2	42.7	2711	–	564
3x 16	4.8	3.4	42.4	44.9	3107	–	595
3x 25	6.0	3.4	45.4	47.9	3659	–	637
3x 35	7.0	3.4	48.0	50.5	4214	–	674
3x 50	8.2	3.4	50.9	53.4	4924	4024	714
3x 70	9.9	3.4	54.6	57.1	5851	4591	766
3x 95	11.5	3.4	58.4	60.9	6973	5260	819
3x120	12.9	3.4	61.8	64.3	8025	5865	867
3x150	14.2	3.4	64.8	67.3	9257	6557	909
3x185	16.2	3.4	69.7	72.2	10802	7472	977
3x240	18.2	3.4	74.4	76.9	12954	8634	1043
3x300	21.2	3.4	81.2	83.7	15397	10000	1138
3x400	23.4	3.4	86.4	88.9	18885	11688	1211
3x500	27.3	3.4	94.8	97.3	22817	13820	1329

CONTINUOUS CURRENT RATINGS (ampere)

nominal area conductor	ground laying								air laying			
	R _t =100 °C cm/W				R _t =200 °C cm/W							
	mm ²	Cu ... Al	Cu .. Al	Cu ... Al	Cu .. Al	Cu ... Al	Cu .. Al	Cu ... Al	Cu .. Al	Cu ... Al	Cu .. Al	
1x 10	98	–	95	–	78	–	72	–	103	–	92	–
1x 16	125	–	120	–	100	–	92	–	137	–	118	–
1x 25	163	–	154	–	126	–	118	–	179	–	154	–
1x 35	195	–	183	–	150	–	140	–	218	–	186	–
1x 50	230	180	216	169	178	138	166	128	260	204	223	174
1x 70	282	220	267	210	216	169	202	159	327	256	278	218
1x 95	342	268	320	252	258	204	243	189	399	312	340	266
1x120	385	305	367	287	293	232	276	215	460	361	396	309
1x150	432	342	410	320	326	258	308	242	521	410	448	352
1x185	490	387	465	363	369	292	347	272	600	471	517	406
1x240	566	450	542	423	425	335	400	316	704	561	612	480
1x300	634	502	607	478	477	379	452	357	811	645	704	553
1x400	721	578	691	548	536	433	510	405	937	756	816	647
1x500	811	654	782	632	607	492	574	460	1081	876	944	756
1x630	902	738	876	712	671	553	645	526	1230	998	1087	882

CONTINUOUS CURRENT RATINGS (ampere)

nominal area conductor	ground laying				air laying	
	R _t =100 °C cm/W		R _t =200 °C cm/W			
	mm ²	Cu	Al	Cu	Al	Cu
3x 10	78	–	66	–	75	–
3x 16	114	–	90	–	108	–
3x 25	148	–	118	–	142	–
3x 35	178	–	140	–	173	–
3x 50	210	165	165	127	206	165
3x 70	258	202	200	156	262	205
3x 95	308	240	238	186	318	247
3x120	350	274	270	209	367	285
3x150	387	305	302	233	406	320
3x185	439	345	340	265	468	368
3x240	514	400	395	308	552	434
3x300	582	454	446	348	630	498
3x400	657	517	507	396	722	572
3x500	746	587	576	452	837	662

CONTINUOUS CURRENT RATINGS (ampere)

nominal area conductor	ground laying				air laying	
	R _t =100 °C cm/W		R _t =200 °C cm/W			
	mm ²	Cu	Al	Cu	Al	Cu
3x 10	77	–	65	–	71	–
3x 16	111	–	89	–	104	–
3x 25	144	–	116	–	142	–
3x 35	170	–	137	–	171	–
3x 50	202	158	161	126	203	159
3x 70	248	196	197	152	252	198
3x 95	297	232	234	182	305	237
3x120	336	263	265	206	351	273
3x150	376	294	292	231	392	305
3x185	423	332	330	260	447	348
3x240	489	385	380	302	524	410
3x300	551	433	428	339	595	470
3x400	622	493	483	386	676	541
3x500	703	562	552	436	781	625

SINGLE-CORE RG7H1R-8.7/15 kV - ARG7H1R-8.7/15 kV

nominal area conductor mm ²	conductor diameter d mm.	insulation thickness mm.	nominal overall diameter D mm.	maximum overall diameter mm.	approximate cable weight kg/km		minimum bending radius mm.
					Cu	Al	
1x 16	4.8	4.5	21.2	23.2	683	—	300
1x 25	6.0	4.5	22.4	24.4	804	—	320
1x 35	7.0	4.5	23.4	25.4	934	—	330
1x 50	8.2	4.5	24.6	26.6	1104	804	350
1x 70	9.9	4.5	26.3	28.3	1346	926	375
1x 95	11.5	4.5	27.9	29.9	1622	1051	395
1x120	12.9	4.5	29.3	31.3	1891	1171	420
1x150	14.2	4.5	31.0	33.0	2252	1352	450
1x185	16.2	4.5	33.0	35.0	2620	1510	470
1x240	18.2	4.5	35.0	37.0	3214	1774	510
1x300	21.2	4.5	38.0	40.0	3812	2013	540
1x400	23.4	4.5	40.2	42.2	4849	2450	574
1x500	27.3	4.5	44.1	46.1	5953	2954	630
1x630	30.5	4.5	47.3	49.3	7131	3353	690

THREE-CORES RG7H10R-8.7/15 kV - ARG7H10R-8.7/15 kV

nominal area conductor mm ²	conductor diameter d mm.	insulation thickness mm.	nominal overall diameter D mm.	maximum overall diameter mm.	approximate cable weight kg/km		minimum bending radius mm.
					Cu	Al	
3x 16	4.8	4.5	42.2	44.4	2594	—	595
3x 25	6.0	4.5	45.4	47.4	3098	—	637
3x 35	7.0	4.5	47.5	49.5	3551	—	667
3x 50	8.2	4.5	50.5	52.5	4229	3329	709
3x 70	9.9	4.5	54.2	56.2	5070	3810	760
3x 95	11.5	4.5	58.2	60.2	6148	4435	816
3x120	12.9	4.5	61.6	63.6	7148	4988	865
3x150	14.2	4.5	64.4	66.4	8257	5557	905
3x185	16.2	4.5	69.1	71.1	9684	6354	970
3x240	18.2	4.5	73.8	75.8	11748	7428	1035
3x300	21.2	4.5	80.7	82.7	14090	8693	1132
3x400	23.4	4.5	85.8	87.8	17448	10251	1204

ARMoured THREE-CORES RG7H10ZR-8.7/15 kV - ARG7H10ZR-8.7/15 kV

nominal area conductor mm ²	conductor diameter d mm.	insulation thickness mm.	nominal overall diameter D mm.	maximum overall diameter mm.	approximate cable weight kg/km		minimum bending radius mm.
					Cu	Al	
3x 16	4.8	4.5	47.7	50.2	3614	—	669
3x 25	6.0	4.5	50.9	53.4	4201	—	714
3x 35	7.0	4.5	53.0	55.5	4708	—	744
3x 50	8.2	4.5	56.0	58.3	5457	4557	786
3x 70	9.9	4.5	59.7	62.2	6390	5130	837
3x 95	11.5	4.5	63.9	66.4	7579	5866	896
3x120	12.9	4.5	67.3	69.8	8663	6503	944
3x150	14.2	4.5	70.1	72.6	9846	7146	983
3x185	16.2	4.5	74.8	77.3	11379	8049	1049
3x240	18.2	4.5	79.5	82.0	13557	9237	1115
3x300	21.2	4.5	86.4	88.9	16059	10662	1211
3x400	23.4	4.5	91.1	93.6	19453	12256	1277

CONTINUOUS CURRENT RATINGS (ampere)

nominal area conductor	ground laying								air laying			
	R _t =100 °C cm/W				R _t =200 °C cm/W							
	mm ²	Cu ●●● Al	Cu ●● Al	Al	Cu ●●● Al	Cu ●● Al	Al	Al	Cu ●●● Al	Cu ●● Al	Al	Al
1x 16	122	–	118	–	98	–	91	–	134	–	122	–
1x 25	160	–	152	–	124	–	118	–	178	–	156	–
1x 35	192	–	181	–	149	–	140	–	214	–	189	–
1x 50	224	176	213	166	173	136	164	127	259	202	226	174
1x 70	276	217	262	205	212	167	200	154	324	254	281	220
1x 95	332	259	314	244	253	197	238	184	394	310	345	268
1x120	376	298	358	281	287	226	271	212	455	361	399	311
1x150	420	331	399	313	319	252	301	235	516	405	451	352
1x185	476	376	452	355	360	284	341	266	592	468	518	406
1x240	550	435	524	413	414	328	393	309	702	556	613	481
1x300	621	492	591	466	464	370	440	348	802	636	705	553
1x400	702	565	670	536	520	422	501	398	921	745	816	646
1x500	787	636	759	616	585	476	566	451	1061	862	944	754
1x630	870	715	849	695	646	536	630	511	1212	987	1087	880

CONTINUOUS CURRENT RATINGS (ampere)

nominal area conductor	ground laying				air laying	
	R _t =100 °C cm/W		R _t =200 °C cm/W			
	mm ²	Cu	Al	Cu	Al	Cu
3x 16	102	–	85	–	98	–
3x 25	146	–	115	–	144	–
3x 35	175	–	136	–	176	–
3x 50	202	160	160	124	209	164
3x 70	248	197	197	152	260	204
3x 95	300	234	232	180	312	244
3x120	336	265	263	204	360	282
3x150	375	298	293	230	408	320
3x185	432	337	334	258	469	368
3x240	504	390	385	304	550	432
3x300	565	442	433	336	632	497
3x400	637	500	491	388	720	572

CONTINUOUS CURRENT RATINGS (ampere)

nominal area conductor	ground laying				air laying	
	R _t =100 °C cm/W		R _t =200 °C cm/W			
	mm ²	Cu	Al	Cu	Al	Cu
3x 16	98	–	82	–	95	–
3x 25	141	–	111	–	141	–
3x 35	168	–	135	–	170	–
3x 50	197	154	156	123	204	160
3x 70	242	189	192	151	252	197
3x 95	289	226	226	177	302	237
3x120	326	254	256	202	345	270
3x150	366	287	288	225	391	306
3x185	412	322	323	254	447	351
3x240	475	373	372	292	521	408
3x300	535	422	421	330	596	469
3x400	606	480	472	376	681	541

SINGLE-CORE RG7H1R-12/20 kV - ARG7H1R-12/20kV

nominal area conductor mm ²	conductor diameter d mm.	insulation thickness mm.	nominal overall diameter D mm.	maximum overall diameter mm.	approximate cable weight kg/km		minimum bending radius mm.
					Cu	Al	
1x 25	6.0	5.5	24.3	26.3	881	–	342
1x 35	7.0	5.5	25.3	27.3	1036	–	360
1x 50	8.2	5.5	26.5	28.5	1217	917	380
1x 70	9.9	5.5	28.2	30.2	1464	1044	400
1x 95	11.5	5.5	30.2	32.2	1777	1206	430
1x120	12.9	5.5	31.6	33.6	2052	1332	450
1x150	14.2	5.5	32.9	34.9	2389	1489	475
1x185	16.2	5.5	34.9	36.9	2765	1655	500
1x240	18.2	5.5	36.9	38.9	3369	1929	540
1x300	21.2	5.5	39.9	41.9	4016	2217	570
1x400	23.4	5.5	42.1	44.1	5026	2627	620
1x500	27.3	5.5	46.8	48.8	6148	3149	670
1x630	30.5	5.5	50.0	52.0	7328	3550	730

THREE-CORES RG7H10R-12/20 kV - ARG7H10R-12/20kV

nominal area conductor mm ²	conductor diameter d mm.	insulation thickness mm.	nominal overall diameter D mm.	maximum overall diameter mm.	approximate cable weight kg/km		minimum bending radius mm.
					Cu	Al	
3x 25	6.0	5.5	49.5	51.5	3483	–	695
3x 35	7.0	5.5	52.2	54.5	4100	–	737
3x 50	8.2	5.5	55.4	57.4	4801	3901	777
3x 70	9.9	5.5	59.1	61.1	5719	4459	830
3x 95	11.5	5.5	62.9	64.9	6675	4962	882
3x120	12.9	5.5	66.0	68.0	7880	5720	926
3x150	14.2	5.5	69.1	71.1	8975	6275	969
3x185	16.2	5.5	73.8	75.8	10444	7114	1035
3x240	18.2	5.5	78.5	80.5	12573	8253	1102
3x300	21.2	5.5	85.4	87.4	14967	9570	1198

ARMoured THREE-CORES RG7H10ZR-12/20 kV - ARG7H10ZR-12/20kV

nominal area conductor mm ²	conductor diameter d mm.	insulation thickness mm.	nominal overall diameter D mm.	maximum overall diameter mm.	approximate cable weight kg/km		minimum bending radius mm.
					Cu	Al	
3x 25	6.0	5.5	55.6	58.1	4751	–	780
3x 35	7.0	5.5	58.0	60.5	5365	–	814
3x 50	8.2	5.5	60.5	63.0	6072	5172	848
3x 70	9.9	5.5	64.8	67.3	7162	5902	909
3x 95	11.5	5.5	68.6	71.1	8329	6616	962
3x120	12.9	5.5	72.1	74.6	9470	7310	1011
3x150	14.2	5.5	74.8	77.3	10676	7976	1049
3x185	16.2	5.5	79.0	81.5	12156	8826	1108
3x240	18.2	5.5	84.2	86.7	14486	10165	1180
3x300	21.2	5.5	90.7	93.2	16965	11568	1271

CONTINUOUS CURRENT RATINGS (ampere)

nominal area conductor	ground laying								air laying			
	R _t =100 °C cm/W				R _t =200 °C cm/W							
	mm ²	Cu ●●● Al	Cu ●● Al	Cu ●●● Al	Cu ●● Al	Cu ●●● Al	Cu ●● Al	Cu ●●● Al	Cu ●● Al	Cu ●●● Al	Cu ●● Al	
1x 25	158	–	152	–	124	–	116	–	176	–	157	–
1x 35	190	–	184	–	147	–	140	–	213	–	192	–
1x 50	225	174	218	168	174	134	167	130	255	202	229	178
1x 70	273	213	267	208	210	164	204	158	321	250	286	222
1x 95	328	257	314	247	250	195	242	189	391	306	348	270
1x120	374	293	358	280	284	221	274	214	451	354	400	312
1x150	416	326	404	315	314	247	306	239	510	404	451	354
1x185	472	369	456	358	356	279	346	269	586	462	520	408
1x240	545	428	528	415	409	322	398	311	690	547	615	482
1x300	612	483	596	470	458	362	447	352	791	630	707	554
1x400	690	550	675	536	513	412	503	401	910	730	818	647
1x500	777	628	762	612	577	462	568	455	1052	852	946	754
1x630	873	712	857	698	647	426	638	519	1192	967	1088	878

CONTINUOUS CURRENT RATINGS (ampere)

nominal area conductor	ground laying				air laying	
	R _t =100 °C cm/W		R _t =200 °C cm/W			
	mm ²	Cu	Al	Cu	Al	Cu
3x 25	150	–	117	–	144	–
3x 35	176	–	136	–	178	–
3x 50	206	160	162	126	206	164
3x 70	252	198	198	155	262	203
3x 95	300	235	235	182	315	246
3x120	342	266	267	208	362	282
3x150	380	298	298	232	408	320
3x185	430	338	336	264	468	366
3x240	502	390	387	302	551	432
3x300	562	440	436	341	632	495

CONTINUOUS CURRENT RATINGS (ampere)

nominal area conductor	ground laying				air laying	
	R _t =100 °C cm/W		R _t =200 °C cm/W			
	mm ²	Cu	Al	Cu	Al	Cu
3x 25	150	–	119	–	140	–
3x 35	178	–	140	–	172	–
3x 50	208	162	162	127	201	160
3x 70	256	199	200	156	250	197
3x 95	300	236	234	183	302	236
3x120	342	267	267	209	348	274
3x150	381	300	297	232	390	309
3x185	432	337	335	263	447	350
3x240	495	391	383	303	522	412
3x300	552	437	428	401	597	472

SINGLE-CORE RG7H1R-15/20 kV - ARG7H1R-15/20kV

nominal area conductor mm ²	conductor diameter d mm.	insulation thickness mm.	nominal overall diameter D mm.	maximum overall diameter mm.	approximate cable weight kg/km		minimum bending radius mm.
					Cu	Al	
1x 35	7.0	6.5	27.3	29.3	1120	–	384
1x 50	8.2	6.5	28.5	30.5	1302	1002	400
1x 70	9.9	6.5	30.6	32.6	1582	1162	430
1x 95	11.5	6.5	32.2	34.2	1873	1302	452
1x120	12.9	6.5	33.6	35.6	2154	1434	472
1x150	14.2	6.5	34.9	36.9	2476	1576	490
1x185	16.2	6.5	36.9	38.9	2873	1763	518
1x240	18.2	6.5	38.9	40.9	3444	2004	546
1x300	21.2	6.5	42.3	44.3	4140	2341	594
1x400	23.4	6.5	44.5	46.5	5118	2719	625
1x500	27.3	6.5	48.6	50.6	6213	3214	682
1x630	30.5	6.5	52.4	54.4	7544	3765	735

THREE-CORES RG7H10R-15/20 kV - ARG7H10R-15/20 kV

nominal area conductor mm ²	conductor diameter d mm.	insulation thickness mm.	nominal overall diameter D mm.	maximum overall diameter mm.	approximate cable weight kg/km		minimum bending radius mm.
					Cu	Al	
3x 35	7.0	6.5	57.2	59.2	4650	–	802
3x 50	8.2	6.5	59.7	61.7	5302	4402	837
3x 70	9.9	6.5	63.8	65.8	6315	5055	895
3x 95	11.5	6.5	67.6	69.6	7426	5713	948
3x120	12.9	6.5	70.6	72.6	8447	6287	990
3x150	14.2	6.5	73.8	75.8	9652	6952	1035
3x185	16.2	6.5	78.0	80.0	11102	7772	1094
3x240	18.2	6.5	82.8	84.8	13044	8724	1161
3x300	21.2	6.5	89.7	91.7	15752	10355	1257

ARMOURED THREE-CORES RG7H10ZR-15/20 kV - ARG7H10ZR-15/20 kV

nominal area conductor mm ²	conductor diameter d mm.	insulation thickness mm.	nominal overall diameter D mm.	maximum overall diameter mm.	approximate cable weight kg/km		minimum bending radius mm.
					Cu	Al	
3x 35	7.0	6.5	69.2	65.4	6053	–	882
3x 50	8.2	6.5	65.4	67.9	6773	5873	917
3x 70	9.9	6.5	69.5	72.0	7884	6624	975
3x 95	11.5	6.5	73.3	75.8	9087	7374	1028
3x120	12.9	6.5	76.3	78.8	10181	8021	1070
3x150	14.2	6.5	79.5	82.0	11461	8761	1115
3x185	16.2	6.5	84.2	86.7	13113	9783	1180
3x240	18.2	6.5	88.5	91.0	15072	10750	1240

CONTINUOUS CURRENT RATINGS (ampere)

nominal area conductor	ground laying								air laying			
	R _t =100 °C cm/W				R _t =200 °C cm/W							
	mm ²	Cu ... Al		Cu .. Al		Cu ... Al		Cu .. Al		Cu ... Al		Cu .. Al
1x 35	188	–	182	–	147	–	142	–	210	–	192	–
1x 50	224	174	215	169	170	134	167	130	252	198	230	177
1x 70	272	212	263	205	210	165	204	158	316	248	285	223
1x 95	326	256	314	247	248	195	242	189	386	302	347	270
1x120	370	290	360	281	284	222	275	213	446	354	401	312
1x150	415	326	401	315	316	247	306	240	506	398	452	354
1x185	470	369	456	357	355	279	345	271	581	452	522	406
1x240	543	429	527	415	408	321	398	312	682	542	616	482
1x300	610	483	593	468	457	361	448	352	782	618	706	551
1x400	688	550	672	535	514	412	506	402	897	720	813	643
1x500	778	626	761	611	578	468	570	457	1032	837	941	752
1x630	873	713	856	695	648	530	640	520	1169	950	1082	874

CONTINUOUS CURRENT RATINGS (ampere)

nominal area conductor	ground laying				air laying	
	R _t =100 °C cm/W		R _t =200 °C cm/W			
	mm ²	Cu	Al	Cu	Al	Cu
3x 35	175	–	137	–	179	–
3x 50	206	161	162	126	210	164
3x 70	250	195	196	154	260	204
3x 95	300	232	134	182	315	247
3x120	340	267	266	208	360	284
3x150	380	298	297	233	406	320
3x185	430	337	337	262	468	366
3x240	498	390	388	302	551	430
3x300	560	441	437	342	632	490

CONTINUOUS CURRENT RATINGS (ampere)

nominal area conductor	ground laying				air laying	
	R _t =100 °C cm/W		R _t =200 °C cm/W			
	mm ²	Cu	Al	Cu	Al	Cu
3x 35	176	–	140	–	172	–
3x 50	205	162	162	128	204	160
3x 70	250	196	199	156	252	197
3x 95	302	235	235	184	305	237
3x120	342	268	268	208	347	271
3x150	380	299	296	232	389	305
3x185	427	337	334	263	447	350
3x240	493	389	384	304	527	410

SINGLE-CORE RG7H1R-18/30 kV - ARG7H1R-18/30 kV

nominal area conductor	conductor diameter d	insulation thickness	nominal overall diameter D	maximum overall diameter	approximate cable weight kg/km		minimum bending radius
					Cu	Al	
mm ²	mm.	mm.	mm.	mm.			mm.
1x 35	7.0	8.0	30.7	32.7	1313	–	431
1x 50	8.2	8.0	31.9	33.9	1568	1268	450
1x 70	9.9	8.0	33.6	35.6	1841	1421	480
1x 95	11.5	8.0	35.2	37.2	2142	1571	500
1x120	12.9	8.0	36.6	38.6	2434	1714	512
1x150	14.2	8.0	37.9	39.9	2786	1886	530
1x185	16.2	8.0	40.3	42.3	3218	2108	565
1x240	18.2	8.0	42.3	45.3	3857	2417	590
1x300	21.2	8.0	45.7	47.7	4527	2728	635
1x400	23.4	8.0	47.9	49.9	5569	3170	670
1x500	27.3	8.0	52.2	54.2	6735	3736	730
1x630	30.5	8.0	55.4	57.4	7939	4161	775

THREE-CORES RG7H10R-18/30 kV - ARG7H10R-18/30 kV

nominal area conductor	conductor diameter d	insulation thickness	nominal overall diameter D	maximum overall diameter	approximate cable weight kg/km		minimum bending radius
					Cu	Al	
mm ²	mm.	mm.	mm.	mm.			mm.
3x 35	7.0	8.0	63.8	65.8	5472	–	895
3x 50	8.2	8.0	67.0	69.0	6414	5514	940
3x 70	9.9	8.0	70.7	72.7	7423	6163	991
3x 95	11.5	8.0	74.5	76.5	8601	6888	1045
3x120	12.9	8.0	77.9	79.9	9737	7577	1092
3x150	14.2	8.0	80.7	82.7	10953	8253	1131
3x185	16.2	8.0	85.4	87.4	12549	9219	1197
3x240	18.2	8.0	89.7	91.4	14721	10401	1257
3x300	21.2	8.0	96.1	98.1	17131	11734	1347

ARMOURED THREE-CORES RG7H10ZR-18/30 kV - ARG7H10ZR-18/30 kV

nominal area conductor	conductor diameter d	insulation thickness	nominal overall diameter D	maximum overall diameter	approximate cable weight kg/km		minimum bending radius
					Cu	Al	
mm ²	mm.	mm.	mm.	mm.			mm.
3x 35	7.0	8.0	69.2	71.7	6990	–	970
3x 50	8.2	8.0	72.7	75.2	8061	7161	1019
3x 70	9.9	8.0	76.4	78.9	9156	7896	1071
3x 95	11.5	8.0	80.2	82.7	10430	8717	1124
3x120	12.9	8.0	83.6	86.1	11644	9484	1172
3x150	14.2	8.0	86.4	88.9	12930	10230	1211
3x185	16.2	8.0	90.7	93.2	14547	11217	1271
3x240	18.2	8.0	95.0	97.5	16817	12497	1332

CONTINUOUS CURRENT RATINGS (ampere)

nominal area conductor	ground laying								air laying			
	R _t =100 °C cm/W				R _t =200 °C cm/W							
	mm ²	Cu ●●● Al		Cu ●● Al		Cu ●●● Al		Cu ●● Al		Cu ●●● Al		Cu ●● Al
1x 35	187	–	180	–	145	–	142	–	213	–	191	–
1x 50	221	173	214	167	172	133	167	131	255	198	230	177
1x 70	272	210	263	205	210	163	204	157	317	247	285	223
1x 95	324	255	312	244	249	195	241	188	386	302	347	270
1x120	369	290	358	280	282	220	274	213	445	348	401	311
1x150	412	323	401	312	314	246	305	238	504	395	452	354
1x185	466	366	452	354	354	278	344	269	581	454	521	405
1x240	538	424	524	412	409	321	397	312	680	534	614	480
1x300	605	480	592	465	458	363	447	352	775	615	703	551
1x400	683	546	670	533	515	412	505	402	895	714	814	643
1x500	775	623	760	610	580	469	571	459	1029	829	942	749
1x630	873	712	859	696	649	530	643	523	1168	950	1083	875

CONTINUOUS CURRENT RATINGS (ampere)

nominal area conductor	ground laying				air laying	
	R _t =100 °C cm/W		R _t =200 °C cm/W			
	mm ²	Cu	Al	Cu	Al	Cu
3x 35	175	–	131	–	178	–
3x 50	204	160	162	128	210	164
3x 70	251	193	197	155	260	203
3x 95	299	233	234	182	315	246
3x120	340	266	268	209	361	280
3x150	377	296	298	233	406	318
3x185	428	335	337	264	466	365
3x240	495	390	387	305	546	429
3x300	562	440	436	342	626	492

CONTINUOUS CURRENT RATINGS (ampere)

nominal area conductor	ground laying				air laying	
	R _t =100 °C cm/W		R _t =200 °C cm/W			
	mm ²	Cu	Al	Cu	Al	Cu
3x 35	175	–	140	–	172	–
3x 50	206	161	163	127	203	158
3x 70	252	196	198	156	251	197
3x 95	298	233	234	184	303	238
3x120	340	265	267	210	346	271
3x150	378	297	296	233	389	305
3x185	427	336	334	263	445	350
3x240	490	388	384	303	522	412

SINGLE-CORE RG7H1R-26/45 kV - ARG7H1R-26/45 kV

nominal area conductor mm ²	conductor diameter d mm.	insulation thickness mm.	nominal overall diameter D mm.	maximum overall diameter mm.	approximate cable weight kg/km		minimum bending radius mm.
					Cu	Al	
1x 70	9.9	10	37.7	40.0	2010	1590	560
1x 95	11.5	10	39.3	41.6	2317	1747	570
1x120	12.9	10	41.1	43.4	2651	1931	590
1x150	14.2	9	40.4	43.0	2828	1928	580
1x185	16.2	9	42.4	45.0	3238	2128	600
1x240	18.2	9	44.4	47.0	3795	2355	640
1x300	21.2	9	47.8	50.3	4547	2748	680
1x400	23.4	9	50.0	52.5	5538	3139	720
1x500	27.3	9	54.3	56.8	6573	3574	790
1x630	30.5	9	58.0	60.5	8040	4262	820

THREE-CORES RG7H10R-26/45 kV - ARG7H10R-26/45 kV

nominal area conductor mm ²	conductor diameter d mm.	insulation thickness mm.	nominal overall diameter D mm.	maximum overall diameter mm.	approximate cable weight kg/km		minimum bending radius mm.
					Cu	Al	
3x 70	9.9	10	81.0	84.0	8882	7622	1136
3x 95	11.5	10	84.8	87.8	10116	8405	1188
3x120	12.9	10	87.8	90.8	11353	9191	1230
3x150	14.2	9	86.3	89.3	11771	9071	1210
3x185	16.2	9	90.6	93.6	13223	9893	1270

ARMOURED THREE-CORES RG7H10ZR-26/45 kV - ARG7H10ZR-26/45 kV

nominal area conductor mm ²	conductor diameter d mm.	insulation thickness mm.	nominal overall diameter D mm.	maximum overall diameter mm.	approximate cable weight kg/km		minimum bending radius mm.
					Cu	Al	
3x 70	9.9	10	87.0	90.0	10878	9618	1220
3x 95	11.5	10	90.3	93.3	12106	10395	1265

CONTINUOUS CURRENT RATINGS (ampere)

nominal area conductor	ground laying								air laying			
	R _t =100 °C cm/W				R _t =200 °C cm/W							
	mm ²	Cu ●●● Al		Cu ●● Al		Cu ●●● Al		Cu ●● Al		Cu ●●● Al		Cu ●● Al
1x 70	264	205	257	200	204	161	199	156	318	248	285	221
1x 95	317	246	307	240	242	192	236	185	384	302	346	270
1x120	360	280	350	272	276	217	268	210	444	347	397	311
1x150	401	315	390	306	305	241	299	236	502	396	448	352
1x185	450	356	442	347	345	271	338	265	575	454	516	404
1x240	521	413	512	402	396	314	391	307	674	531	608	477
1x300	585	466	576	453	443	352	438	345	768	611	697	547
1x400	660	534	654	520	498	398	496	392	880	708	807	638
1x500	741	603	740	593	558	450	558	447	1013	821	934	743
1x630	847	792	836	676	636	517	631	509	1177	960	1069	865

CONTINUOUS CURRENT RATINGS (ampere)

nominal area conductor	ground laying				air laying	
	R _t =100 °C cm/W		R _t =200 °C cm/W			
	mm ²	Cu	Al	Cu	Al	Cu
3x 70	240	189	194	152	256	201
3x 95	289	225	230	180	308	240
3x120	326	256	261	205	354	276
3x150	367	287	291	227	398	313
3x185	415	326	329	258	457	357

CONTINUOUS CURRENT RATINGS (ampere)

nominal area conductor	ground laying				air laying	
	R _t =100 °C cm/W		R _t =200 °C cm/W			
	mm ²	Cu	Al	Cu	Al	Cu
3x 70	244	189	193	150	263	205
3x 95	290	227	230	181	316	247

APPARENT ELECTRIC RESISTANCE OF THE CONDUCTOR (Ohm/Km) AT 50Hz AND AT 90°C

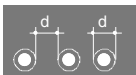

Single-core cables

nominal area conductor mm ²	copper conductors				aluminium conductors			
	1.8/3 kV 3.6/6 kV	6/10 kV 8.7/15 kV	12/20 kV 15/20 kV 18/30 kV	26/45 kV	1.8/3 kV 3.6/6 kV	6/10 kV 8.7/15 kV	12/20 kV 15/20 kV 18/30 kV	26/45 kV
10	2.35	2.35	—	—	—	—	—	—
16	1.49	1.48	—	—	—	—	—	—
25	0.937	0.936	0.936	—	—	—	—	—
35	0.674	0.676	0.676	—	—	—	—	—
50	0.500	0.499	0.499	—	0.818	0.818	0.818	—
70	0.345	0.345	0.345	0.345	0.566	0.566	0.566	0.566
95	0.249	0.248	0.248	0.248	0.409	0.409	0.409	0.409
120	0.198	0.197	0.197	0.197	0.323	0.323	0.323	0.323
150	0.161	0.161	0.161	0.161	0.263	0.263	0.263	0.263
185	0.127	0.127	0.127	0.127	0.210	0.210	0.210	0.210
240	0.0984	0.0983	0.0982	0.0981	0.160	0.160	0.161	0.161
300	0.0789	0.0787	0.0788	0.0786	0.130	0.130	0.130	0.129
400	0.0624	0.0624	0.0623	0.0622	0.102	0.102	0.102	0.102
500	0.0496	0.0495	0.0494	0.0491	0.0812	0.0810	0.0812	0.0805
630	0.0395	0.0394	0.0393	0.0391	0.0649	0.0646	0.0649	0.0645



Single-core cables

nominal area conductor mm ²	all voltages	
	copper cond.	aluminium cond.
10	2.35	—
16	1.48	—
25	0.936	—
35	0.675	—
50	0.499	0.818
70	0.345	0.566
95	0.250	0.409
120	0.197	0.322
150	0.162	0.265
185	0.130	0.211
240	0.0995	0.163
300	0.0805	0.133
400	0.0644	0.106
500	0.0521	0.0853
630	0.0429	0.0704



Three-cores cables

nominal area conductor mm ²	all voltages	
	copper cond.	aluminium cond.
10	2.35	—
16	1.48	—
25	0.937	—
35	0.675	—
50	0.499	0.818
70	0.344	0.565
95	0.250	0.410
120	0.198	0.325
150	0.163	0.264
185	0.130	0.213
240	0.100	0.164
300	0.0815	0.134
400	0.0658	0.108
500	0.0536	0.0879

CAPACITY VALUES AT 50 Hz (µF/Km)

nominal area conductor mm ²	1.8/3 kV	3.6/6 kV	6/10 kV	8.7/15 kV	12/20 kV	15/20 kV	18/30 kV	26/45 kV
10	0.25	0.21	0.16	—	—	—	—	—
16	0.28	0.23	0.18	0.15	—	—	—	—
25	0.33	0.26	0.21	0.18	0.17	—	—	—
35	0.37	0.29	0.23	0.19	0.17	0.15	0.14	—
50	0.42	0.34	0.25	0.21	0.18	0.17	0.15	—
70	0.48	0.39	0.29	0.23	0.21	0.19	0.19	0.14
95	0.50	0.43	0.32	0.26	0.23	0.20	0.18	0.16
120	0.55	0.47	0.36	0.29	0.25	0.21	0.19	0.17
150	0.59	0.50	0.37	0.31	0.27	0.24	0.20	0.19
185	0.65	0.55	0.42	0.33	0.29	0.26	0.21	0.21
240	0.75	0.63	0.47	0.37	0.32	0.27	0.24	0.23
300	0.82	0.66	0.52	0.43	0.35	0.31	0.27	0.25
400	0.85	0.69	0.56	0.45	0.39	0.34	0.29	0.28
500	0.91	0.79	0.64	0.51	0.43	0.38	0.32	0.30
630	1.02	0.88	0.73	0.57	0.49	0.43	0.36	0.33

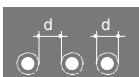

Single-core cables (average value)

nominal area conductor mm ²	1.8/3 kV	3.6/6 kV	6/10 kV	8.7/15	12/20 kV	15/20 kV	18/30 kV	26/45 kV
10	0.19	0.20	0.21	–	–	–	–	–
16	0.18	0.19	0.20	0.21	–	–	–	–
25	0.18	0.18	0.19	0.20	0.21	–	–	–
35	0.17	0.18	0.19	0.19	0.20	0.20	0.21	–
50	0.16	0.17	0.18	0.19	0.19	0.20	0.20	–
70	0.16	0.17	0.17	0.18	0.19	0.19	0.20	0.21
95	0.16	0.16	0.17	0.17	0.18	0.18	0.19	0.20
120	0.15	0.16	0.16	0.17	0.18	0.18	0.18	0.19
150	0.15	0.16	0.16	0.17	0.17	0.18	0.18	0.19
185	0.15	0.15	0.16	0.16	0.17	0.17	0.18	0.18
240	0.14	0.15	0.16	0.16	0.16	0.17	0.17	0.18
300	0.14	0.15	0.15	0.16	0.16	0.16	0.17	0.17
400	0.14	0.15	0.15	0.15	0.16	0.16	0.16	0.17
500	0.14	0.14	0.15	0.15	0.15	0.16	0.16	0.17
630	0.14	0.14	0.15	0.15	0.15	0.15	0.16	0.16



Single-core cables

nominal area conductor mm ²	1.8/3 kV	3.6/6 kV	6/10 kV	8.7/15	12/20 kV	15/20 kV	18/30 kV	26/45 kV
10	0.13	0.14	0.16	–	–	–	–	–
16	0.12	0.14	0.15	0.15	–	–	–	–
25	0.12	0.13	0.14	0.14	0.15	–	–	–
35	0.11	0.12	0.13	0.14	0.14	0.15	0.16	–
50	0.11	0.11	0.12	0.13	0.13	0.14	0.15	–
70	0.10	0.11	0.12	0.12	0.13	0.13	0.14	0.15
95	0.098	0.10	0.11	0.12	0.12	0.13	0.13	0.14
120	0.095	0.10	0.11	0.11	0.12	0.12	0.13	0.14
150	0.091	0.098	0.10	0.11	0.11	0.12	0.12	0.13
185	0.089	0.094	0.10	0.11	0.11	0.11	0.12	0.12
240	0.086	0.091	0.097	0.10	0.11	0.11	0.11	0.12
300	0.084	0.089	0.095	0.098	0.10	0.11	0.11	0.12
400	0.082	0.087	0.091	0.096	0.098	0.10	0.11	0.11
500	0.081	0.083	0.089	0.092	0.096	0.098	0.10	0.11
630	0.079	0.082	0.087	0.090	0.093	0.096	0.098	0.10



Three-cores cables

nominal area conductor mm ²	1.8/3 kV	3.6/6 kV	6/10 kV	8.7/15	12/20 kV	15/20 kV	18/30 kV	26/45 kV
10	0.11	0.12	0.14	–	–	–	–	–
16	0.10	0.12	0.13	0.14	–	–	–	–
25	0.097	0.11	0.12	0.13	0.14	–	–	–
35	0.093	0.10	0.11	0.12	0.13	0.13	0.14	–
50	0.087	0.096	0.11	0.12	0.12	0.13	0.13	–
70	0.084	0.092	0.10	0.11	0.11	0.12	0.13	0.14
95	0.081	0.088	0.097	0.10	0.10	0.11	0.12	0.13
120	0.079	0.086	0.094	0.10	0.10	0.11	0.12	0.13
150	0.077	0.084	0.091	0.097	0.10	0.11	0.11	0.12
185	0.075	0.082	0.087	0.094	0.097	0.10	0.11	0.11
240	0.074	0.079	0.085	0.090	0.094	0.098	0.10	–
300	0.072	0.077	0.084	0.088	0.092	0.096	0.10	–
400	0.071	0.075	0.082	0.086	–	–	–	–
500	0.070	0.074	0.078	–	–	–	–	–

AMBIENT TEMPERATURE DIFFERENT FROM STANDARD CONDITIONS

Ambient temperature °C	15	20	25	30	35	40	45	50	55	60	65
Ground laying cables	1.04	1.00	0.96	0.92	0.88	0.84	0.80	–	–	–	–
Air Cables*	–	1.09	1.09	1.00	0.95	0.90	0.85	0.79	0.74	0.67	0.60

* Not exposed to direct sunlight

THREE-CORES CABLES (OR SINGLE-CORE CABLES ENCLOSED IN TREFOIL) GROUNDED LAYING

Number of cables or trefoil-set (horizontally)		2	3	4	6
	7 cm	0.84	0.74	0.67	0.60
Space between cables or trefoil-sets	25 cm	0.86	0.78	0.74	0.69

THREE-CORES CABLES (OR SINGLE-CORE CABLES ENCLOSED IN TREFOIL) GROUNDED PIPE LAYING

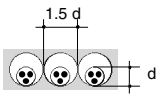

Number of cables (horizontally)	1	2	3
	0.82	0.69	0.61

THREE-CORES CABLES AIR LAYING

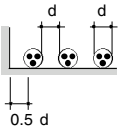

Number of cables (horizontally)	1	2	3	6	9
	0.95	0.90	0.88	0.85	0.84

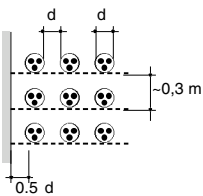

Number of cables (horizontally)		1	2	3	6	9
Number of layers (vertically)	1	1.00	0.98	0.96	0.93	0.92
	2	1.00	0.95	0.93	0.90	0.89
	3	1.00	0.94	0.92	0.89	0.88
	6	1.00	0.93	0.90	0.87	0.86

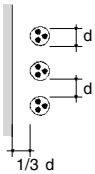

Number of cables (vertically)	1	2	3	6	9
	1.00	0.93	0.90	0.87	0.86

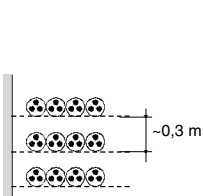

Number of cables (horizontally)		1	2	3	6	9
Number of layers (vertically)	1	0.95	0.84	0.80	0.75	0.73
	2	0.95	0.80	0.76	0.71	0.69
	3	0.95	0.78	0.74	0.70	0.68
	6	0.95	0.76	0.72	0.68	0.66



Number of cables (vertically)	1	2	3	6	9
	0.95	0.78	0.73	0.68	0.66

SINGLE-CORE CABLES TREFOIL AIR LAYING

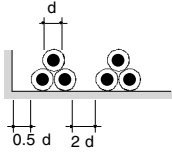

Number of trefoil sets (horizontally)	1	2	3	6	9
	0.95	0.90	0.88	0.85	0.84

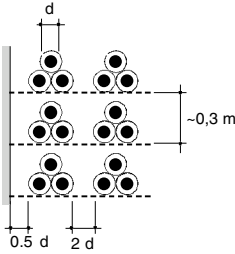

Number of trefoil sets (horizontally)		1	2	3	4	6
Number of layers (vertically)	1	1.00	0.98	0.96	0.93	0.92
	2	1.00	0.95	0.93	0.90	0.89
	3	1.00	0.94	0.92	0.89	0.88
	6	1.00	0.93	0.90	0.87	0.86

SINGLE-CORE CABLES AIR LAYING HORIZONTALLY AND VERTICALLY SPACED OUT

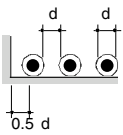

Number of trefoil sets (horizontally)	1	2	4
	0.92	0.89	0.97

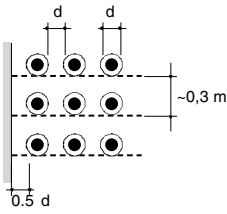

Number of trefoil sets (horizontally)		1	2
Number of layers (vertically)	1	1.00	0.97
	2	0.97	0.94
	3	0.96	0.93

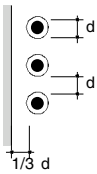

Number of trefoil sets (vertically)	1	2
	0.94	0.91

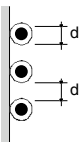

Number of trefoil sets (vertically)	1	2
	0.89	0.86

PHASE LAY-OUT FOR SINGLE-CORE CABLES CONNECTED IN PARALLEL TO PROVIDE CORRECT CURRENT SPLITTING

Trefoil laying cables

Number of trefoil sets in the same layer*	2	3	4
	T RS T SR	T RS T SR T RS	T RS T SR T RS T SR

Horizontally or vertically spaced-out cables

Number of trefoil sets in the same layer*	2	4
	RST TSR	RST TSR RST TSR

*When cables are installed on several layers their lay-out must be repeated for each layer.

SHORT CIRCUIT RATING

The maximum short circuit current allowed for short period of time (a few seconds) for copper or aluminium conductors can be calculated by the following formula:

$$I_{cc} = \frac{K \cdot S}{t} \text{ (A)}$$

where:
I_{cc} = short circuit current (A)
K = factor of the conducting material which obtained from the difference between starting and final temperature of short circuit;
 K copper = 143
 K aluminium = 92
S = area conductor (mm²)
t = duration of short circuit (sec.)

The following table reports the values in KA of the current calculated for the starting temperature of 90°C and for the duration of 1 second.

Area conductor mm ²	Copper	Aluminium
10	1.4	0.9
16	2.3	1.5
25	3.6	2.3
35	5.0	3.2
50	7.1	4.6
70	10	6.4
95	14	8.7
120	17	11
150	21	14
185	26	17
240	34	22
300	43	28
400	57	37
500	72	46
630	90	58

K factor (final temperature = 250°C)

Material Conductor	Starting temperature		
	50	70	90
copper	165	154	143
aluminium	107	100	92

To calculate the current allowed in the screen you can use the same formula indicated above for the conductor with the factor K = 180°C.

VOLTAGE DROP

The voltage drop can be calculated by the following formula for connections in alternating current:

$$\Delta V = K \cdot L \cdot I (R \cdot \cos\phi + X \cdot \sin\phi)$$

where:
ΔV = voltage drop (V)
K = 1,73 for three-phase system
K = 2 for single-phase system
L = connection length (km)
I = current rating (A)
R = conductor resistance at using temperature (Ohm/km)
X = phase reactance (Ohm/km)
cosφ = power factor

For direct current connection cosφ = 1

COMPARISON BETWEEN RATED VOLTAGES AND INSULATION RATE

Insulation rate	Nominal voltage kV U ₀ /U	Maximum voltage kV U _m
8	1.8/3	3.6
11	3.6/6	7.2
17	6/10	12
24	8.7/15	17.5
32	12/20	24
47	18/30	36
67	26/45	52

U₀ = relates to the nominal tension between a conductor and earth
U = relates to the nominal tension between the conductors of the cable
U_m = greatest tension which the cable is suitable

The final tests to which the **Medium Voltage** cables are subjected are in compliance with IEC 60502-2 standard.

Routine tests

- Electrical resistance of conductor
- Partial discharge on cables having cores with conductors screens and insulation screens
- Voltage test

Sample tests

- Conductor examination
- Chek of dimensions
- Voltage test for cable of rated voltage above 3,6/6 (7.2) kV
- Hot set test for EPR, HEPR and XLPE insulations and elastomeric sheaths

Electrical type tests

- Partial discharge test
- Bending test
- Tan δ measurement
- Heating cycle test
- Impulse test
- Voltage test

Non-electrical type tests

- Thickness of insulation
- Thickness of non-metallic sheaths
- Mechanical properties of insulation before and after ageing
- Mechanical properties of non-metallic sheaths before and after ageing
- Additional ageing test of completed cables
- Loss of mass test on PVC sheaths of type ST₂
- Pressure test at high temperature on insulation and non-metallic sheaths
- Test on PVC insulation and sheaths at low temperatures
- Test for resistance of PVC insulation and sheaths to cracking (heat shock test)
- Ozone resistance test for EPR anf HEPR insulations
- Hot set test for EPR, HEPR and XLPE insulation and elastomeric sheaths
- Oil immersion test for elastomeric sheaths
- Water absorption test on insulation
- Flame retardance test
- Carbon black content of black PE oversheath
- Shrinkage test for XLPE insulation
- Thermal stability test for PVC insulation
- Determination of hardness of HEPR insulation
- Determination of elastic modulus of HEPR insulation
- Shrinkage test for PE oversheaths
- Strippability test for insulation scren
- Water penetration test

Electrical tests after installation

Tests after installation are made, if required, when the installation of the cable and its accessories has been completed. They are for new installations only.

- d.c. voltage equal to 4 U₀ shall be applied for 15 min.

As an alternative, and by agreement between the contractor and purchaser, an a.c. voltage tes at power frequency, in accordance with indicated below:

- test for 5 min. with the phase-to-phase voltage of the system applied between the conductor and the metallic screen;
- test for 24 hours with the normal operating voltage of the system.

Insulation rated voltage U ₀ kV	Electrical tests after installation in c.c. for 15' kV
3.0	12
3.6	14.4
6.0	24
8.7	34.8
12	48
18	72
26	104

STORAGE AND HANDLING

The drums storage and movement shall be carried out with crane or forklift truck. It is not allowed to drop drums from the truck to the floor. All cables during transport and handling can be damaged so we suggest to verify before and during installation procedure any possible damage to avoid heavy problems during cable working life. For the benefit of the workers involved in electrical work is absolutely necessary to observe some safety rules normally indicated on the local still in force standards.

Do not remove staves and cable end caps until the cable will be laid down. If you cut a piece of cable leaving the rest in a open stock put on again ends protections. Unwind and rewind cables as shown in the pictures. In case of transferring from one drum to another remember the minimum bending cable radius and consequently the barrel drum diameter.

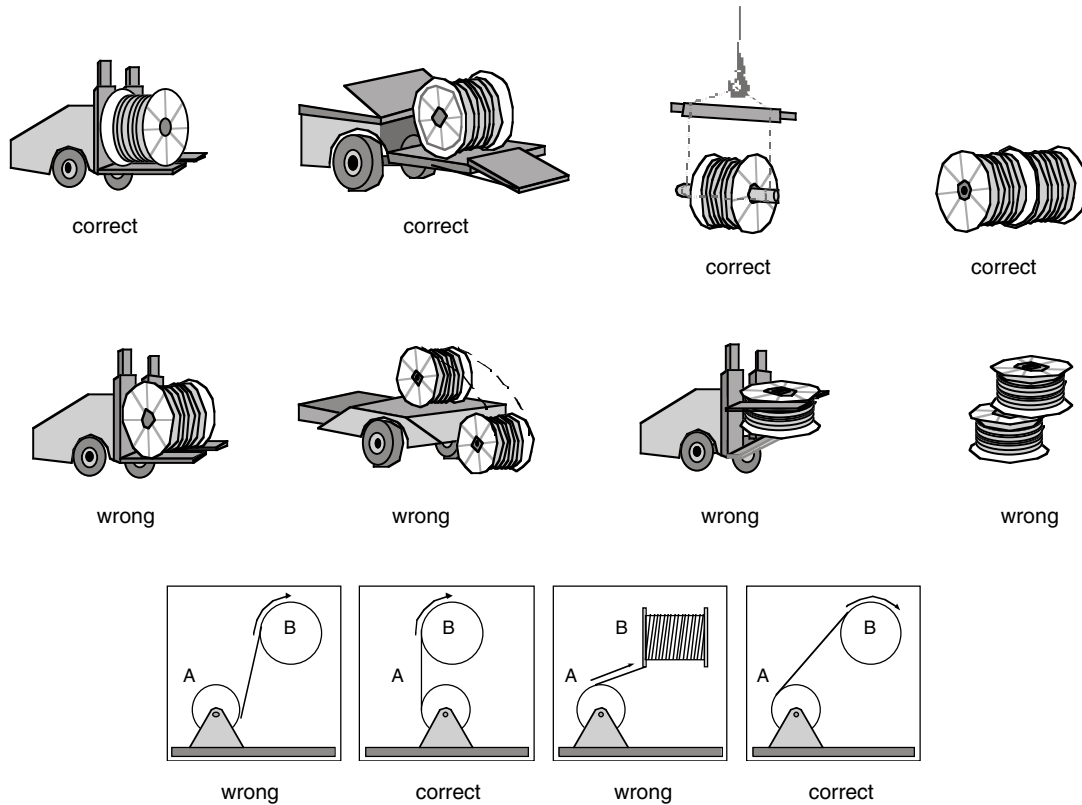

INSTALLATION

We summarize some rules to be observed during the installation of MV cables for fixed laying. In order to provide easy operations we suggest do not work at cable temperature below than 5°C. Cables bending radius are indicated in Range and Dimensions tables and they must be to value carefully. For unarmoured cables and in order to pull cable inside pipes or trench it is advisable to apply the pull force on the conductors being careful do not exceed 5 kg/mm² of total area for copper cables and 3 kg/mm² for aluminium cables.

Example:

copper cable	1 x 240 mm ² :	max pull force kg	1200
aluminium cable	1 x 240 mm ² :	max pull force kg	720
copper cable	3 x 240 mm ² :	max pull force kg	3600
aluminium cable	3 x 240 mm ² :	max pull force kg	2160

For steel cable armour the strain rope will be applied to the armour while the pull force by steel braid is advisable only for limited efforts.

If there are curves along the lay route must be placed a sufficient conveyers, for example at the entrance of pipes, suitable to keep the cable in the right direction line in order to avoid to exceed the maximum pulling load allowed.

Concerning overhead cables any strain will be charged on the supporting rope for installation operations and during working time.

Besides data reported in this booklet is always important to consider the effects of thermal dissipation. All installations in parallel trefoil must be realized with maximum care in order to aim the most balanced charge distribution on the cables connected to the same phase. Therefore please consider the following information:

- all cables must have the same metal conductors
- all cables must have the same length and section
- the bundle cables must be made-up following R, S and T phases system as indicated on page 29
- the cables must be properly spaced
- right and balanced connections to the cables terminals

How to draw the cable

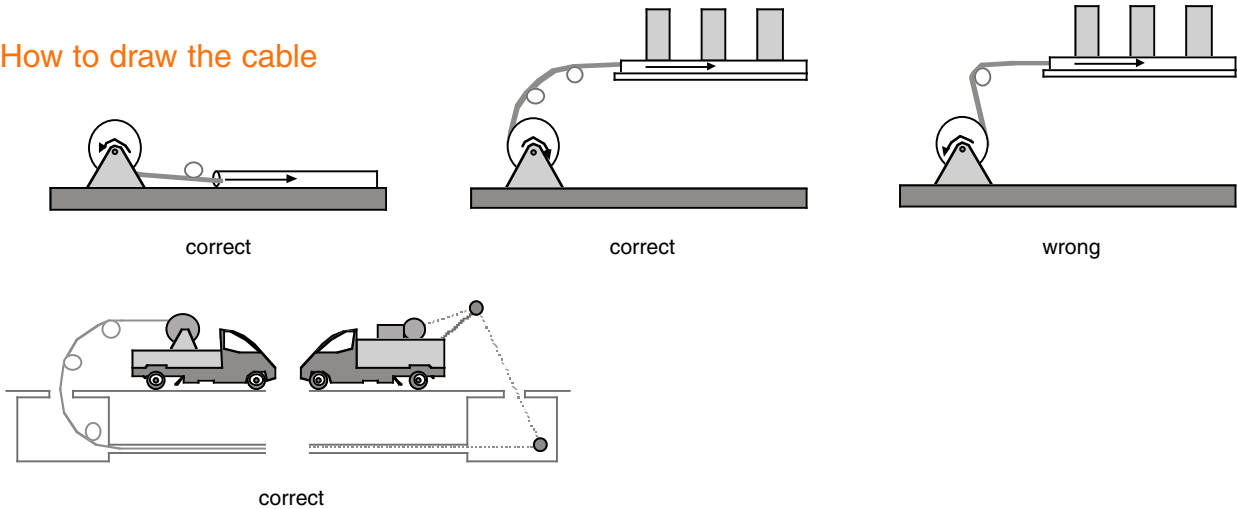

PACKAGING

DRUMS CAPACITY (meters)

Cable diameter mm	DRUM TYPE											
	BL60	BL70	BL80	BL90	BL100	BL120	BL140	BL160	BL180	BL200	BL220	BL250
11	446	769	994	130	2041	3441	5248	5991	8320	11896	13901	17758
14	275	475	614	3	1260	2124	3240	3698	5137	7344	8582	10963
17	187	322	416	805	855	1441	2197	2508	3484	4981	5820	7435
20	135	233	301	546	617	1041	1588	1812	2517	3599	4205	5372
23	102	176	227	394	467	787	1200	1370	1903	2721	3180	4062
26	80	138	178	298	365	616	939	1072	1489	2129	2488	3179
29		111	143	233	294	495	755	862	1197	1712	2000	2555
34		80	104	188	202	365	549	627	871	1245	1455	1859
40			75	136	154	260	397	453	629	900	1051	1343
46				99	117	197	300	343	476	680	795	1015
52					91	154	235	268	372	532	622	795
58						124	189	215	299	428	500	639
64						102	155	177	246	351	411	525
70							130	148	205	294	343	439
76							110	125	174	249	291	372
82							94	108	150	214	250	320
88								94	130	186	217	277
94									114	163	190	243
100									101	144	168	215
105									91	131	153	195
110										119	139	178

HOW TO SELECT THE DRUM

Example:

1 - kind cable RG7H1R-12/20 kV 1x240 mm² see page 18
 overall cable diameter mm 39.1 a round figure mm 40
 minimum bending radius mm 560
 cable quantity mt 500

2 - **determination of drum barrel diameter** = mm 560 x 2 = 1120 mm consequently qualified drums are BL180/200/220/250. ■

3 - **outcome** = following above practice the more convenient drum able to contain mt 500 is BL 180 ■

DRUMS DIMENSION

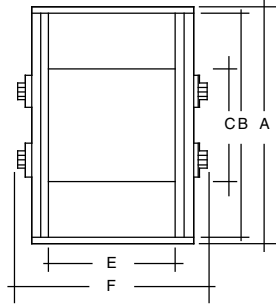
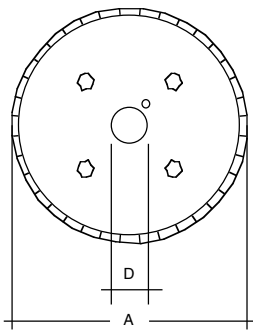

A - Flange diameter including circumference batten
 B - Flange diameter without circumference batten
 C - Inner barrel diameter
 D - Axis hole
 E - Inner width
 F - External width

DRUM TYPE	A mm	B mm	C mm	D mm	E mm	F mm	Drum weight Kg	Batten weight Kg	Global volume m ³
BL60	690	630	315	80	315	435	15	11	0.17
BL70	770	710	355	80	400	515	20	16	0.25
BL80	860	800	400	80	450	575	25	21	0.34
BL90	960	900	450	80	450	575	36	23	0.42
BL100	1.060	1.000	500	80	560	685	44	30	0.62
BL120	1.310	1.250	630	80	630	760	77	42	1.10
BL140	1.460	1.400	710	80	750	920	113	56	1.60
BL160	1.660	1.600	900	80	900	1.070	182	75	2.40
BL180	1.860	1.800	1.120	80	1.120	1.320	319	106	3.70
BL200	2.060	2.000	1.250	125	1.120	1.320	387	121	4.50
BL220	2.300	2.240	1.400	125	1.120	1.320	478	135	5.60
BL250	2.510	2.450	1.500	125	1.120	1.320	560	148	6.50

NOTE

The data belong to the standard wooden drums daily in force in all Tratos Cavi facilities. Nevertheless for uncommon cable lengths there are available very large wooden and metallic drums. In this cases transport restrictions have to be considered like special law-loading trailers and permits from traffic authorities in accordance with local regulations.

- A.C.** - Alternating current in which the charge-flow periodically reverses
- Accessories** - Components necessary to cables network connection
- Aluminium conductor** - An aluminium wire or group of wires
- Aluminium screen** - Usually a longitudinal smooth or corrugated aluminium tape overlapped and thermosealed
- AWG** - America Wire Gauge
- Bending radius** - Minimum bending radius a cable can be bent without permanent damage
- BS** - British Standard (UK)
- Cable tray** - A channel system used to hold and support power cable
- Cable pipe** - A pipe used to contain power cable
- Capacitance** - The value of the capacity of a dielectric material between two conductors
- CEI** - Comitato Elettrotecnico Italiano
- Compacted conductor** - Ensure regular conductor diameter avoiding stress to insulation layer
- Conductor losses** - Power losses due to the resistance of conductors
- Conductor screen** - An extrusion layer direct on the cable conductor of a semi-conducting material to provide regular distribution of electrical stress
- Copper conductor** - A copper wire or group of wires
- Copper screen** - Overlapping spiral-wound copper tapes or copper wires to coil up
- Dielectric** - Generally a non metallic material with high resistivity
- Dielectric constant** - The relation between the charge by a condenser with dielectric material and vacuum
- D.C.** - Direct current
- Dielectric losses** - Power losses due to the conductance of dielectric materials
- Dielectric strength** - Maximum voltage gradient that a material withstand
- Embossing code** - Raised cable code on the outersheath
- Electrical resistance** - The resistance of the materials to the flow of current (Ohm/km)
- Electrical metal screen** - A metal shield against external fields, need to equalize electric fields
- Electromagnetic compatibility** - The capability of different electrical system to coexist without interferences
- Electrical gradient** - The sheare of dielectrical strength express in kV/mm
- Filler** - Mass of material to fill laying cores interstices in order to provide an approximate round shape cable, through extrusion or by different elements assembled together cores
- Frequency** - The number of cycles (hertz) of an alternating current in one second
- HEPR** - High ethylene propylene rubber
- IEC** - International Electrotechnical Committee
- Insulation** - Dielectric layer
- Insulation screen** - An extrusion layer direct on the cable insulation of a semi-conducting material which uniform radial stress distribution across insulation
- Jacket** - The outer protective covering of a cable
- Joints** - Accessory suitable to joint two cables
- Laying depth** - Installation depth trench
- Lug** - Accessory suitable to connect a cable conductor to the network
- Metallic armour** - Additional mechanical cable protection usually covered by a plastic layer
- M1** - LSOH low smoke and zero halogen
- MT** - Medium tension
- MV** - Medium voltage
- NF** - Norme Française (F)
- Phase lay-out** - System to provide a correct current splitting
- PE** - Polyethylene
- Plain conductor** - Mean a conductor of only one metal
- Print code** - Ink print cable code in the outersheath
- PVC** - Polyvinyl chloride
- Reactance** - The opposition to the flow of alternating current by inductance or capacitance
- Resistivity** - A conductor electric resistance
- Semiconductor** - A material with lower electrical resistance than a dielectric material
- Sheath** - The outer protective covering of a cable
- Short circuit current** - Breakdown due temperature rise
- Single core** - One phase cable
- System** - Network
- Terminations** - Accessory suitable to connect a cable to the network
- Trefoil** - Lay-out of three single cable
- Three cores** - Three phases cables
- Uo kV** - Nominal tension between any insulated conductor to earth
- U kV** - Nominal tension between two insulated conductor of the cable
- Um kV** - Maximum tension which the cable is suitable
- UNE** - Unificación de Normas Españolas (E)
- VDE** - Verband der Elektrotechnik (D)
- Voltage drop** - Reduced voltage in the circuit
- XLPE** - Cross-linked polyethylene

Tratos Cavi S.p.A. reserves the right to modify at any time technical dimensional and weight characteristics shown in this catalogue to improve the features of its products.

However these will still be in accordance to the mentioned standards.

There is no responsibility of the manufacturer for damages to persons and property in case of improper use and/or neglecting the recommendations for using cables and norms contained in this catalogue.

TRATOS



ALMA S.r.l.
Via Stadio, 2
52036 Pieve S. Stefano - Italy
Tel. +39 0575 7941
Fax +39 0575 798026

TRATOS CAVI S.p.a.
Via Stadio, 2
52036 Pieve S. Stefano - Italy
Tel. +39 0575 7941
Fax +39 0575 798026
commerciale@tratos.it

TRATOS CAVI S.p.a.
filiale Catania
XIII Str. Strad. V.Lancia
Loc. Piano D'Arco
95121 Catania - Italy
Tel. +39 095 7482101
Fax +39 095 291059

TRATOS H.V. S.p.a.
Via Pian di Guido, 45
52036 Pieve S. Stefano - Italy
Tel. +39 0575 799429
Fax +39 0575 796907

TRATOS Ltd
UK - Park Road
Holmewood Industrial Park
Holmewood - Chesterfield
DERBYSHIRE S42 5UW
Tel. +44 01246 858000
Fax +44 01246 858001

NORTH WEST CABLES Ltd
School lane, Knowsley
Merseyside L34 9HD
Tel. +44 01515 483888
fax +44 0151 549 1169

TRATOS CAVI Iberica S.L.
Spain
Paseo de los Parques 6, bloque 6, 1D
28109 Alcobendas (Madrid)
Tel./ Fax +34 91 6255887

MEDIUM VOLTAGE CABLES

RUBBER INSULATION

Engineering Data for
Copper and Aluminium
Conductors